

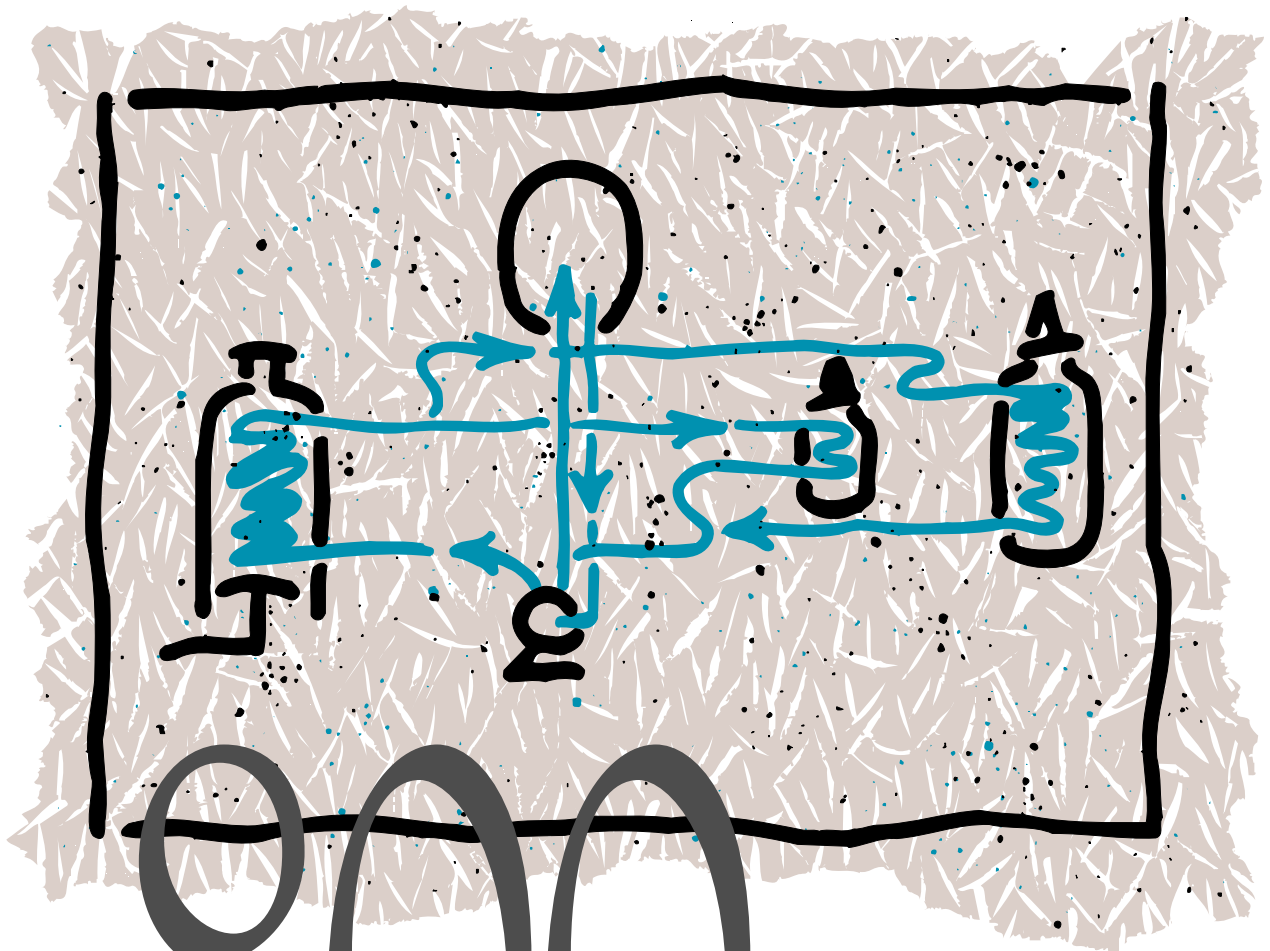

SYLTHERM 800 Heat Transfer Fluid



800

Product Technical Data

CONTENTS

SYLTHERM 800 Heat Transfer Fluid	
Introduction	3
Performance	3
Fluid Selection Criteria	4
Thermal Stability	4
Equilibrium and Operating Pressures	5
Expansion Tank	5, 6
Simplified Schematic for Loop Design	7
Corrosivity	8
Flammability and Fire Hazards	8, 9
New System Start-up	10
Health and Safety Considerations	11
Customer Service	11
Technical Support and Assistance	11
Fluid Analysis	11
Retrofill	12
Shipping Limitations	12
Storage and Shelf-life	12
Packaging.....	12
Properties and Engineering Characteristics	
Physical Properties	12
Vapor Properties	
English Units	13
SI Units	13
Liquid Saturation Properties	
English Units	14
SI Units	15
Thermal Conductivity	16
Calculated Heat of Vaporization	17
Vapor Pressure	18
Specific Heat	19
Density	20
Viscosity	21
Engineering Data	
Liquid Film Coefficient	
English Units	22
SI Units	23
Pressure Drop	
English Units	24
SI Units	25
Thermal Expansion	26
Typical Liquid Phase Heating Scheme	27

For Information About Our Full Line of Fluids...

To learn more about the full line of heat transfer fluids manufactured or distributed by Dow — including DOWTHERM* synthetic organic, SYLTHERM† silicone and DOWTHERM, DOWFROST*, and DOWCAL* glycol-based fluids — request our product line guide. Call the number for your area listed on the back of this brochure.

*Trademark of The Dow Chemical Company

†Trademark of Dow Corning Corporation

SYLTHERM 800 Heat Transfer Fluid

A Virtually Odorless, Long-lasting Heat Transfer Fluid

SYLTHERM[†] 800 fluid is a highly stable, long-lasting, silicone fluid designed for high-temperature liquid-phase operation. It has a recommended operating temperature range of -40°F (-40°C) to 750°F (400°C). Operating continuously at the upper end of this range, SYLTHERM 800 fluid exhibits low potential for fouling and can often remain in service for 10 years or more. The fluid is essentially odorless and is low in acute oral toxicity. Silicone heat transfer fluids such as SYLTHERM 800 fluid are not listed as reportable under SARA Title III, Section 313.¹

SYLTHERM 800 fluid features include:

- Low fouling potential
- Low freeze point
- High-temperature stability
- Long life
- Noncorrosive
- Low acute oral toxicity
- Low odor
- Non-reportable under SARA Title III, Section 313¹

SYLTHERM 800 heat transfer fluid provides excellent high-temperature stability. It is capable of operating more than 10 years at 750°F (400°C) without the fouling or periodic reprocessing problems associated with other heat transfer media.

Performance

SYLTHERM 800 heat transfer fluid has an operational temperature range of -40°F (-40°C) to 750°F (400°C). Maximum recommended film temperature is 800°F (427°C).

The silicone polymer structure is shown in Figure 1. Under operational thermal stress, the fluid undergoes very slow rearrangement of the silicone-oxygen bonds to assume a composition that remains stable at the required operating temperature and pressure. The rate of molecular rearrangement is directly related to the temperature and is depressed substantially because of the patented formulation. Systems using SYLTHERM 800 fluid require no periodic venting; therefore, the low-molecular-weight linear and cyclic siloxanes that result from the rearrangement remain part of the heat transfer media and do not cause system fouling. The rearrangement that occurs with SYLTHERM 800 heat transfer fluid is not a degradation reaction and does not affect fluid life.

Figure 1 — Dimethyl Polysiloxane Molecule

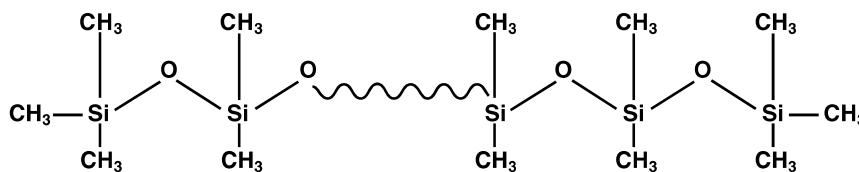

[†]Trademark of Dow Corning Corporation

¹You may need to comply with similar or additional legislation in other countries. Contact your Dow representative for information.

FLUID SELECTION CRITERIA

Stability

SYLTHERM 800 fluid offers good thermal stability at temperatures up to 750°F (400°C). The maximum recommended film temperature is 800°F (427°C).

Freeze Point

SYLTHERM 800 fluid has a minimum pumpability temperature less than -40°F (-40°C).

Low Odor, Non-reportable

The chemical composition of SYLTHERM 800 fluid makes it a preferred choice for users with the need for low odor. Additionally, SYLTHERM 800 has no components currently listed as reportable under SARA Title III, Section 313.¹ SYLTHERM 800 is not a hazardous product as defined in the OSHA Hazard Communication Standard.

Thermal Stability

The thermal stability of a heat transfer fluid is dependent on many factors. Properly maintained SYLTHERM 800 heat transfer fluid can be aged continuously at 750°F (400°C) for more than 10 years before it needs replacement. Longer fluid life can be expected in systems operating at lower temperatures.

Heat Transfer Capability

The exceptional thermal stability of SYLTHERM 800 heat transfer fluid results in uniquely stable heat trans-

fer properties. Because it exhibits low potential for fouling, large correction factors for fouling in heat transfer coefficient calculations are not needed (a fouling factor of 0.0001 (hr)(ft²)(°F)/Btu [1.45×10^{-5} m²K/W] is commonly used). Additionally, the unique rearrangement chemistry of SYLTHERM 800 heat transfer fluid can offset the viscosity increases characteristic of heat transfer fluids as they age. The result is that, throughout its life, the film heat transfer coefficient of SYLTHERM 800 heat transfer fluid can remain as good as, or can improve above, the original fluid values.

Three key areas of focus for heat transfer operations are designing and operating the heater and/or energy recovery unit, preventing chemical contamination, and eliminating fluid contact with air and water.

When units are operated at high temperatures, fluid velocities in heaters should be a minimum of 6 feet per second (2 m/s); a range of 6 to 12 feet per second (2–4 m/s) should cover most cases. The actual velocity selected will depend on an economic balance between the cost of circulation and heat transfer surface.

Operating limitations are usually placed on heat flux by the equipment manufacturer. This heat flux is determined for a maximum film temperature by the operating conditions of the particular unit.

Heater Design and Operation

Poor design and/or operation of the fired heater can cause overheating and will eventually cause the fluid's viscosity to increase to a point where replacement of the fluid is necessary to restore system performance. Taken to an extreme, such as extended aging above

1000°F (538°C) with low or no flow, polymer cross-linking may occur. This will eventually cause the fluid viscosity to increase, requiring fluid replacement. Some problem areas to be avoided include:

1. Flame impingement.
2. Operating the heater above its rated capacity.
3. Modifying the fuel-to-air mixing procedure to change the flame height and pattern. This can yield higher flame and gas temperatures together with higher heat flux.
4. Low fluid velocity/high heat flux areas resulting in excessive heat transfer fluid film temperatures.

The manufacturer of the fired heater should be the primary contact in supplying you with the proper equipment for your heat transfer system needs.

Contamination and Oxidation Effects

At elevated temperatures, SYLTHERM 800 heat transfer fluid is sensitive to contamination. Contamination by acids or bases can result in accelerated rates of volatile by-product formation. Contamination by water, oxygen, or other oxidants can result in cross-linking of polymer molecules, and, if not corrected, can cause a gradual increase in viscosity.

It is important that contamination be minimized. Potential sources of contaminants such as water, steam, process material, atmospheric air, and humidity should be appraised and modifications made where necessary.

¹You may need to comply with similar or additional legislation in other countries. Contact your Dow representative for information.

Equilibrium and Operating Pressures

SYLTHERM 800 heat transfer fluid does not have a distinct boiling point. Its molecular weight distribution shifts with time at high temperatures, affecting vapor pressure, viscosity, flash point, and freeze point. Once the fluid composition reaches equilibrium at a temperature (usually a matter of months), an “equilibrium vapor pressure” can be measured.

As supplied, SYLTHERM 800 heat transfer fluid exhibits a low vapor pressure. With time at high temperatures, the previously described rearrangement reaction results in a gradually rising vapor pressure. Ultimately, the silicone components reach an equilibrium composition and exhibit an equilibrium vapor pressure.

The curves on page 18 represent typical equilibrium pressures for SYLTHERM 800 heat transfer fluid. In practice, operating pressures in the expansion tank are often higher than values indicated by the curve due to the additive effect of other gases such as the nitrogen blanket gas or noncondensable by-products of operation.

Information specific to SYLTHERM 800 heat transfer fluid can be found in this brochure under these sections: “Expansion Tank,” “Flammability and Fire Hazards,” and “New System Start-up.” Consult “Equipment for Systems Using DOWTHERM Heat Transfer Fluids” (Form No. 176-1335) for general suggestions on designing a heat transfer loop using SYLTHERM 800 heat transfer

fluid to meet your process requirements. (For a copy of this brochure, please contact your nearest Dow representative or call the number for your area listed on the back of this brochure.)

In some system designs, lower expansion-tank pressures than those derived from the curves in Figures 7 and 8 (page 18) are required because of equipment design constraints. This method of operation results in venting of low-molecular-weight volatile materials from the system, which requires periodic make-up with new fluid. Contact your nearest Dow representative or call the number for your area listed on the back of this brochure for assistance if you plan to design your system with pressures below the curves in Figures 7 and 8.

Expansion Tank

Figure 2 (page 7) is a simplified schematic of a recommended system loop design for SYLTHERM 800 heat transfer fluid. The expansion tank may be positioned at the highest point in the system and has the capability for full flow of the heat transfer fluid through the tank. This design allows the expansion tank to be the lowest pressure point in the system, and the constant flow of heat transfer fluid through the tank ensures that vapors form only in the expansion tank. Once the system is heated up to the appropriate temperature and operating normally, system pressure will slowly increase until either the pressure in the expansion tank reaches the setting on the back pressure regulator valve, or the system reaches the equilibrium vapor pressure for the temperature of the fluid in the expansion tank. When the back pressure regulator is set at a pressure

lower than the equilibrium vapor pressure of the fluid for a given temperature, periodic venting of the volatile materials will take place. The fluid will suffer no deleterious effect; however, periodic additions of new fluid will be needed to maintain system volume.

An inert gas (such as nitrogen) blanket on the expansion tank is required to prevent the fluid from coming into contact with the outside air. Without this inert gas blanket, humid, outside air is likely to be drawn into the tank whenever the system cools below its normal operating temperature. This moisture contamination can result in increased pressure in the system due to steam formation on the next heat-up cycle. To avoid this, the inert gas supply regulator should be adjusted and maintained at a low setting of 3 to 5 psi (0.2 to 0.3 bar). This will minimize both the inert gas consumption and the additive effects of the blanket gas on total system pressure.

Figures 7 and 8 show the ultimate equilibrium silicone vapor pressure that SYLTHERM 800 heat transfer fluid should generate over a period of time at the indicated temperatures. Because systems using SYLTHERM 800 heat transfer fluid are typically designed to contain all low molecular weight materials in the system, all temperatures and pressures at various points in the system should fall on or above the curved line to prevent pump cavitation or two-phase flow. To prevent pump cavitation, the fluid pressure at the entrance to the pump must be above its vapor pressure, and there must be sufficient head in addition to the vapor pressure to satisfy the Net Positive Suction Head (NPSH) requirements of the pump.

If the expansion tank is designed as shown in Figure 2, the back pressure regulator setting on the expansion tank will control the pressure at the entrance to the pump. The regulator set point should be a minimum of 10 to 15 psi (0.7 to 1.0 bar) above the vapor pressure corresponding to the fluid temperature in the expansion tank.

NPSH requirements are primarily satisfied by the elevation of the expansion tank. The elevation is determined by calculating the total head necessary to overcome frictional line losses and specific NPSH requirements of the pump. In systems where such tank elevation is not practical, NPSH requirements can be met by increasing the amount of the blanket gas (usually nitrogen) in the vapor space of the expansion tank, thereby increasing the overall pressure in the tank. However, the additional system pressure created by the nitrogen should be accounted for during the system design.

In some cases, design constraints, such as permissible process vessel pressures, limit the maximum allowable pressures for a system, thereby limiting the back pressures that can be used in the expansion tank. In these situations, the maximum back pressure on the expansion tank is determined by the constraining pressure on the system. When the back pressure on the expansion tank at a given temperature is less than the pressure exerted by the low molecular weight materials in the

tank, some of these materials will be vented out of the system. Since these materials are largely responsible for the vapor pressure exerted by SYLTHERM 800 heat transfer fluid, their removal will enable system operating pressures below those shown by the curves in Figs. 7 and 8.

The rate of venting will be determined primarily by the system temperature profile and the setting of the back pressure regulator. Several systems using SYLTHERM 800 heat transfer fluid are operating at pressures below the pressure-temperature curves (Figs. 7 and 8) providing process service temperatures that would not be possible with competitive heat transfer fluids in the equipment as designed. For additional details on how to design a system with operating pressures below this line, as well as comments on its expected operational fluid loss rates, contact your nearest Dow representative or call the number for your area listed on the back of this brochure.

Whether the loop is designed to operate as a closed system or at a reduced pressure, the expansion tank design must satisfy two necessary requirements for proper start-up and operation of the system. First, the system piping to the expansion tank should be designed to permit full flow of fluid through the tank. A double drop leg design (see Fig. 2, page 7) is the most effective arrangement to remove air, water vapors and other noncondensibles during system start-up. The tank and connecting piping should also be insulated to prevent the condensation of any vapors that may accumulate in this portion of the system.

Second, the inert gas blanket on the expansion tank should allow for a continuous flow of inert gas to be purged through the vapor space during the initial start-up. Separate inert gas supply and discharge nozzles, spaced as far apart as possible, will help ensure that any volatile contaminants (such as water or solvents) will be swept from the system during initial start-up.

The vent lines from the safety relief valve and back pressure regulator should be discharged to a safe area away from open flame and other potential sources of ignition. An appropriate outside container located well away from building air-intake fans is recommended. The vented volatile materials will be typically classified as flammable.

The expansion tank should be sized so that it is approximately $\frac{1}{4}$ full when the system is at ambient temperature, and $\frac{3}{4}$ full when the system is at its maximum operating temperature. Expansion tank instrumentation and fittings must meet the design requirements of the anticipated operating temperatures and pressures of the system and should include (refer to Fig. 2):

1. Electronic level gauge covering the full fluid-level range.
2. Fluid temperature indicator.
3. Level alarm (high/low) with low-level shutdown to protect pump.
4. Pressure indicator with high-pressure alarm.

Figure 2 — Simplified System Schematic for SYLThERm 800 Heat Transfer Fluid

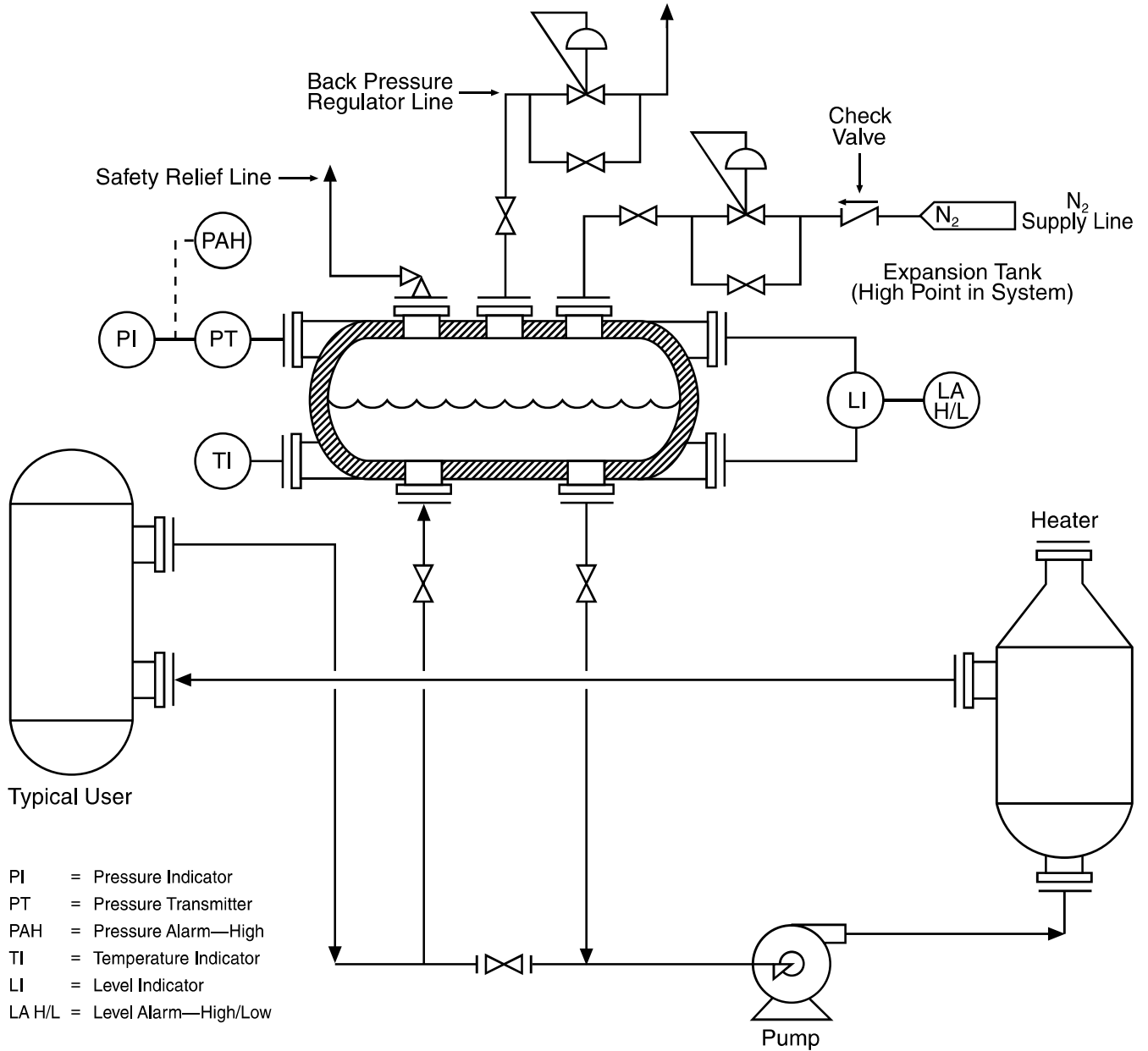

Tracing

The low freezing point of SYLTHERM 800 heat transfer fluid allows the fluid to be pumped at any temperature normally encountered in an industrial environment. Therefore, freeze protection is not required on any fluid transfer lines. However, a portion of the low molecular weight volatile materials formed during normal operation will crystallize at 142°F (61°C). These crystalline materials are readily soluble in SYLTHERM 800 heat transfer fluid and will not be formed at any place in the system except where a cold vapor space exists. Thus all vapor-containing lines that feed instrumentation and gauges, the inert gas supply lines, back pressure regulator, vent lines, and the safety relief valves and lines must be maintained at a minimum temperature of 150°F (66°C) during operation in order for them to function properly. Insulation and tracing materials used for this purpose must be capable of tolerating the expected surface temperatures of the piping when the system is in operation. A low-temperature alarm to alert operating personnel that the tracing system is not functioning is also recommended.

Electrical tracing, steam tracing, and tracing systems using a slipstream of the heat transfer fluid have all been successfully used on systems with SYLTHERM 800 heat transfer fluid. The slipstream-type system generally requires fewer piping components and is considered to be both reliable and economical.

For added safety, the tracing system can be extended to include the piping downstream of the safety relief valve since these valves often develop small leaks while in service. Where long runs of piping make tracing impractical, an alternative solution is to install a rupture disk device between the safety relief valve and the protected vessel. Application of a rupture disk device should be carefully evaluated to ensure that it meets the requirements of Section VIII of the ASME Boiler and Pressure Vessel Code.

Corrosivity

SYLTHERM 800 heat transfer fluid is noncorrosive toward common metals and alloys as long as it remains uncontaminated. Even at high temperatures, equipment usually exhibits excellent service life.

Carbon steel is used predominantly, although low alloy steels, stainless steels, monel alloy, etc., are also used in miscellaneous pieces of equipment and instruments.

Most corrosion problems are caused by chemicals introduced into the system during cleaning or from process leaks. The severity and nature of the corrosivity will depend upon the amounts and type of contamination involved.

When special materials of construction are used, extra precautions should be taken to avoid contaminating materials containing the following:

Construction Material	Contaminant
<i>Austenitic Stainless Steel</i>	<i>Chlorides</i>
<i>Nickel</i>	<i>Sulfur</i>
<i>Copper Alloys</i>	<i>Ammonia</i>

Flammability and Fire Hazards

All organic heat transfer fluids may operate at temperatures substantially above their flash and fire points. This is also the case with SYLTHERM 800 heat transfer fluid. However, when proper precautions are taken in system designs and procedures, these materials can be used.

The following paragraphs describe the fire and explosion hazards of SYLTHERM 800 heat transfer fluid. This data sheet presents general guidelines for design.

Flash Point

Like many high-temperature heat transfer fluids, SYLTHERM 800 heat transfer fluid normally operates above its flash and fire points. The rearrangement reaction generates low-molecular-weight silicone polymers that, in their pure states, are either flammable or combustible. In systems that operate near or above the equilibrium vapor pressure, most of these low-molecular-weight materials remain in the fluid. This results in the flash point of the fluid decreasing during operation until the level of low-molecular-weight components reaches a constant concentration. At this point the fluid could have a closed-cup flash point near 100°F (40°C). The actual number will vary from system to system.

Because the vapor space in the expansion tank will contain low-molecular-weight silicone polymers that are potentially flammable at ambient temperatures, vapor vents and safety relief lines must be vented to safe areas away from sparks or open flames.

SYLTHERM 800 heat transfer fluid generates low-molecular-weight hydrocarbon gases during operation at high temperatures, although to a much lesser extent than organic heat transfer fluids. For SYLTHERM 800 heat transfer fluid, the hydrocarbon gas is predominantly methane. Methane is flammable, and appropriate precautions must be taken. The concentration of methane in a given heat transfer system is highly dependent on temperatures, pressures, degree of contamination, and other operational factors. The flash point data for SYLTHERM 800 heat transfer fluid are reported without methane present.

Mists also present a flammability hazard. Mists resulting from minor leaks contain a very small amount of mass and dissipate quickly. Therefore, these mists do not present a major hazard if no other flammables are present. However, any large leaks that generate a mist cloud should be treated as significant flammability hazards.

Static Spark Hazard

Heat transfer fluids like SYLTHERM 800 heat transfer fluid are generally poor electrical conductors, which means they can build up static charges and discharge static electricity within vessels or while being drained out of vessels. Therefore, safe engineering practice dictates that oxygen must be excluded from the head-space of the expansion tank. Similar precautions concerning static sparks should be taken when loading and unloading used fluid and volatiles.

Autoignition Point

The autoignition temperature of SYLTHERM 800 heat transfer fluid is typically 725°F (385°C), and this value remains relatively constant during use. Nitrogen blanketing on the expansion tank is required to help maintain a safe and inert operational environment. Spills or leaks at or above 725°F (385°C) are potentially hazardous. However, operating experience with systems with fluid at or slightly above the 750°F (385°C) maximum recommended temperature has shown that these leaks do not necessarily result in autoignited fires. It is believed that when this type of minor operational leak occurs, the fluid cools to below its autoignition point before it reaches the air.

Heat Release

Under carefully controlled pool fire conditions, SYLTHERM 800 heat transfer fluid was found to generate less heat and was easier to extinguish than organic heat transfer fluids. An independent testing laboratory performed a series of tests to characterize the fire-hazard potential of SYLTHERM 800 heat transfer fluid relative to conventional organic heat transfer fluids. In side-by-side pool burns, organic heat transfer fluids were shown to release five to ten times more heat to the surroundings than SYLTHERM 800 heat transfer fluid. In addition, values for mass-loss rate, oxygen-depletion rate, and smoke-release rate were found to be considerably lower for SYLTHERM 800 heat transfer fluid.

Flammable Gas Detectors

Silicone vapors can deactivate many brands of flammable gas detectors. However, several manufacturers offer detectors for silicone environments. They report the operating life of these detectors is not affected by the presence of silicone materials. For listings of suppliers of these detectors, contact your nearest Dow representative or call the number for your area listed on the back of this brochure.

NEW SYSTEM START-UP

The following information is a brief summary of general recommendations and procedures for starting up a new system with SYLTHERM 800 heat transfer fluid.

Prior to start-up, the system must be cleaned of dirt, welding slag and other miscellaneous debris. Extra care taken to keep the system clean during construction can eliminate extensive cleaning prior to start-up. As mentioned previously, it is also very important to remove any residual water from the system prior to the installation of SYLTHERM 800 heat transfer fluid.

Because the design of all heat transfer systems differs to some extent, a detailed set of start-up procedures covering all possible systems is not practical. Users should develop procedures based on their own internal standards and recommendations from heat transfer equipment suppliers. The following procedures are presented as general guidelines only.

1. If the system is flushed with water or a suitable solvent, be sure that the fluid is circulated sufficiently through the system to pick up any remaining oils and debris. The pump and suction strainer should be checked periodically during this time to ensure that any collected debris is not severely restricting fluid flow to the pump inlet. If a filter is installed, filter the fluid for as long as practical through a 10-micron filter.

2. Completely drain the flush fluid by pressurizing the system with nitrogen or dry air, and opening all low-point drains. Alternately open and close all drain valves to increase the velocity of the gas flow. This will help to remove residual water/solvent and loose foreign particles.

3. Fill the system with SYLTHERM 800 heat transfer fluid. *For systems where the Stability Additive has been shipped separately, typically systems with fluid volumes greater than 5,000 gallons (20,000 liters), do not add the Stability Additive at this time.* Circulate the fluid cold. Check for and repair any leaks. If a flush fluid was not used, check the pump suction strainers for any collected solids. If a filter is installed, continue circulating the fluid through the filter until the upper temperature limit of the filter is approached.

4. For the initial stages of start-up, the inert gas blanket system on the expansion tank should be arranged to allow a steady purge (1 to 2 scfm) of gas to sweep through the vapor space of the tank. At the same time, the valves controlling fluid flow should be set so that the maximum amount of fluid flows through the expansion tank.

5. Increase the fluid temperature to 250°F (120°C) as measured at the heater outlet. The rate of increase should be held to 100°F (40°C) per hour or the maximum recommended for the various pieces of equipment in the system, whichever is lower. This will allow the equipment to be brought up to temperature safely and enable start-up personnel to

check for leaks and ensure that all instrumentation is operating properly. Maintain the 250°F (120°C) temperature until the amount of steam or solvent vapors exiting the vent line from the expansion tank has subsided. This may require several hours.

6. Raise the fluid temperature to 300°F (150°C) and repeat the procedure described above until venting has again subsided. Repeat the procedure once more at 350°F (175°C).

It is essential that sufficient flow of fluid be maintained through the expansion tank during these steps so that the temperature in the tank is high enough to boil out any residual moisture or solvents from the system. After the moisture has been thoroughly removed from the system, lower the fluid temperature to 200°F (100°C). *Once the fluid temperature has reached 200°F (100°C), add the Stability Additive.*

7. Set the nitrogen supply regulator in the range of 3 to 5 psig (0.2 to 0.3 bar). Engage the back pressure regulator at the specified design pressure. No further venting will occur unless the pressure in the expansion tank exceeds the specified pressure. Any further pressure increase in the tank should only result from compression of the inert gas by the expanding fluid or from the generation of volatile materials by SYLTHERM 800 heat transfer fluid. Any additional inert gas should enter the tank only when the tank pressure falls below the 3 to 5 psig (0.2 to 0.3 bar) setting (e.g., as it would if the system were to be shut down).

HEALTH AND SAFETY CONSIDERATIONS

A Material Safety Data Sheet (MSDS) for SYLTHERM 800 heat transfer fluid is available by calling the number for your area listed on the back of this brochure or by contacting your nearest Dow representative. The MSDS contains complete health and safety information regarding the use of this product. Read and understand the MSDS before handling or otherwise using this product.

SYLTHERM 800 heat transfer fluid has been studied for acute toxicological properties under the Federal Hazardous Substance Act (FHSA) guidelines. As a result of the FHSA study, SYLTHERM 800 heat transfer fluid can be classified as:

- Nontoxic with regard to acute oral ingestion or dermal absorption
- Neither an eye nor a skin irritant

Additional studies indicate that repeated, prolonged skin contact should not result in irritation. Normal industrial handling procedures are adequate to handle this product.

When SYLTHERM 800 heat transfer fluid leaks, an aerosol comprised of a mist and white smoke is evolved. The mist is mostly unchanged fluid, but oxidation of the hot vapor in air produces some toxic by-products, including carbon monoxide. Exposure to the mist and decomposition by-products may cause serious, transient irritation of the respiratory tract and watering of the eyes. Watering of the eyes or throat irritation indicates excessive levels of hot vapor leaks. In areas of adequate ventilation no special breathing apparatus is required. However, prolonged exposure or exposure in poorly

ventilated areas with high concentrations of mist and decomposition by-products should be avoided.

Leaks should be repaired as soon as they occur to reduce the potential for smoke inhalation and loss of fluid.

The predominant vented by-products of thermal decomposition are low-molecular-weight dimethylsiloxanes. The low toxicity of these cyclic and linear siloxanes is inferred by their common use in such personal care products as cosmetics and deodorants.

CUSTOMER SERVICE FOR USERS OF SYLTHERM 800 HEAT TRANSFER FLUID

Fluid Analysis

The Dow Chemical Company, and its affiliates, offer an analytical service for SYLTHERM 800 heat transfer fluid. It is recommended that users send a one-pint (0.5 liter) representative sample at least annually to:

North America & Pacific

The Dow Chemical Company
Larkin Lab/Thermal Fluids
1691 North Swede Road
Midland, Michigan 48674
United States of America

Europe

Dow Benelux NV
Testing Laboratory for SYLTHERM
and DOWTHERM Fluids
Oude Maasweg 4
3197 KJ Rotterdam – Botlek
The Netherlands

Latin America

Dow Quimica S.A.
Fluid Analysis Service
1671, Alexandre Dumas
Santo Amaro – Sao Paulo –
Brazil 04717-903

This analysis gives a profile of fluid changes to help identify trouble from product contamination or thermal decomposition.

Fluid Sampling Procedures

When a sample is taken from a hot system it should be cooled to below 100°F (40°C) before it is put into the shipping container. Cooling the sample below 100°F (40°C) will prevent the possibility of thermal burns to personnel; also, the fluid is then below its flash point. In addition, any low boilers will not flash and be lost from the sample. Cooling can be done by either a batch or continuous process. The batch method consists of isolating the hot sample of fluid from the system in a properly designed sample collector and then cooling it to below 100°F (40°C). After it is cooled, it can be withdrawn from the sampling collector into a container for shipment.

The continuous method consists of controlling the fluid at a very low rate through a steel or stainless steel cooling coil so as to maintain it at 100°F (40°C) or lower as it comes out of the end of the cooler into the sample collector. Before a sample is taken, the sampler should be thoroughly flushed. This initial fluid should be returned to the system or disposed of in a safe manner in compliance with all laws and regulations.

It is important that samples sent for analysis be representative of the charge in the unit. Ordinarily, samples should be taken from the main circulating line of a liquid system. Occasionally, additional samples may have to be taken from other parts of the system where specific problems exist. A detailed method for analyzing the fluid to determine its quality is available upon request.

Used heat transfer fluid which has been stored in drums or tanks should be sampled in such a fashion as to ensure a representative sample.

Retrofill

SYLTHERM 800 heat transfer fluid has successfully replaced organic fluids in existing heat transfer systems. However, there are engineering considerations that should be addressed due to the unique characteristics of SYLTHERM 800 heat transfer fluid. It is suggested that The Dow Chemical Company be consulted in advance of fluid purchase and installation to discuss how best to optimize fluid performance in your system.

Shipping Limitations

SYLTHERM 800 heat transfer fluid is classified by U.S. D.O.T. as non-hazardous. However, used fluid or volatiles will have different flammability ratings, and appropriate handling precautions should be taken. Regulations vary by country; check with your Dow representative.

Storage and Shelf-life

SYLTHERM 800 heat transfer fluid, when stored in its original container,

will meet sales-specification requirements for a period of 5 years from date of shipment.

Store fluid at ambient temperature.

Packaging

SYLTHERM 800 heat transfer fluid is routinely supplied in 420-pound (191 kg) containers (net weight) and in bulk quantities.

Table 1 — Physical Properties of SYLTHERM 800 Fluid¹

Composition: Dimethyl polysiloxane

Property	As Supplied		After Extended Use ²	
	English Units	SI Units	English Units	SI Units
Color:	Clear Yellow		Darkened	
Viscosity at 77°F (25°C)	9.1 cP	9.1 mPa•s	≥ 6.0 cP	≥ 6.0 mPa•s
Flash Point ³ , Closed Cup, Typical	320°F	160°C	≥ 95°F	≥ 35°C
Flash Point ⁴ , Open Cup, Typical	350°F	177°C	≥ 135°F	≥ 57°C
Fire Point ³	380°F	193°C	≥ 155°F	≥ 68°C
Autoignition Point, ASTM D 2155	725°F	385°C	725°F	385°C
Acid Number, Typical	0.03		0.03	
Freeze Point	-76°F	-60°C	≤ -40°F	≤ -40°C
Density at 77°F (25°C)	7.8 lb/gal	936 kg/m ³	7.8 lb/gal	936 kg/m ³
Specific Gravity at 77°F (25°C)	0.93		0.93	
Heat of Combustion	12,300 Btu/lb	28,659 kJ/kg	12,300 Btu/lb	28,659 kJ/kg
Estimated Critical Constants				
T _c	692°F	367°C	692°F	367°C
P _c	10.8 atm	10.9 bar	10.8 atm	10.9 bar
V _c	0.0515 ft ³ /lb	3.22 l/kg	0.0515 ft ³ /lb	3.22 l/kg

¹ Not to be construed as specifications.

² Properties of the fluid at "equilibrium." Can be regarded as ongoing, long-term values for design purposes.

³ ASTM D92

⁴ ASTM D93

Table 2 — Saturated Vapor Properties of SYLTHERM 800 (English Units)
Values are based on an Equation of State

Temp. °F	ΔH_{lv} Btu/lb	Molecular Weight	Z_{vapor}	C_p/C_v
200	89.0	223.2	0.990	1.019
220	86.1	228.3	0.990	1.019
240	83.3	233.0	0.988	1.019
260	80.6	237.5	0.985	1.018
280	77.9	241.8	0.981	1.018
300	75.3	245.8	0.975	1.018
320	72.8	249.6	0.968	1.017
340	70.4	253.3	0.960	1.017
360	68.1	256.8	0.952	1.017
380	65.8	260.2	0.942	1.017
400	63.5	263.6	0.931	1.016
420	61.3	266.9	0.920	1.016
440	59.2	270.2	0.909	1.016
460	57.1	273.6	0.896	1.016
480	55.0	277.0	0.884	1.016
500	52.9	280.4	0.871	1.015
520	50.9	284.0	0.858	1.015
540	48.8	287.8	0.844	1.015
560	46.8	291.7	0.831	1.015
580	44.8	295.9	0.818	1.015
600	42.8	300.2	0.805	1.015
620	40.7	304.9	0.792	1.014
640	38.7	309.9	0.779	1.014
660	36.6	315.2	0.767	1.014
680	34.5	320.8	0.755	1.014
700	32.4	326.9	0.744	1.014
720	30.3	333.4	0.733	1.014
740	28.1	340.4	0.723	1.014
760	25.8	347.8	0.714	1.014

Table 3 — Saturated Vapor Properties of SYLTHERM 800 (SI Units)
Values are estimated on an Equation of State

Temp. °C	ΔH_{lv} kJ/kg	Molecular Weight	Z_{vapor}	C_p/C_v
100	203.0	226.3	0.990	1.019
110	197.0	230.7	0.989	1.019
120	191.2	234.9	0.987	1.019
130	185.5	238.8	0.984	1.019
140	180.0	242.6	0.980	1.018
150	174.7	246.2	0.974	1.018
160	169.4	249.6	0.968	1.018
170	164.4	252.9	0.961	1.018
180	159.4	256.1	0.953	1.017
190	154.6	259.2	0.945	1.017
200	149.8	262.3	0.936	1.017
210	145.2	265.3	0.926	1.017
220	140.6	268.2	0.916	1.017
230	136.1	271.2	0.905	1.016
240	131.7	274.2	0.894	1.016
250	127.4	277.3	0.883	1.016
260	123.0	280.4	0.871	1.016
270	118.8	283.7	0.859	1.016
280	114.5	287.0	0.847	1.016
290	110.3	290.5	0.835	1.015
300	106.0	294.2	0.823	1.015
310	101.8	298.0	0.811	1.015
320	97.6	302.1	0.799	1.015
330	93.3	306.4	0.788	1.015
340	89.0	310.9	0.776	1.015
350	84.7	315.7	0.766	1.015
360	80.3	320.8	0.755	1.014
370	75.9	326.3	0.745	1.014
380	71.4	332.1	0.735	1.014
390	66.8	338.2	0.726	1.014
400	62.2	344.8	0.718	1.014

Table 4 — Saturated Liquid Properties of SYLTHERM 800 Fluid (English Units)

Temp. °F	Specific Heat Btu/lb °F	Density lb/ft³	Thermal Conductivity Btu/hr ft² (°F/ft)	Viscosity cP	Vapor Pressure psia
-40	0.360	61.91	0.0845	51.0	0.0
-20	0.364	61.25	0.0833	34.2	0.0
0	0.369	60.60	0.0821	24.2	0.0
20	0.374	59.96	0.0809	18.0	0.0
40	0.378	59.32	0.0797	13.8	0.0
60	0.383	58.69	0.0785	10.9	0.0
80	0.387	58.06	0.0773	8.8	0.0
100	0.392	57.44	0.0761	7.3	0.0
120	0.396	56.82	0.0749	6.1	0.0
140	0.401	56.21	0.0736	5.1	0.1
160	0.405	55.59	0.0724	4.4	0.1
180	0.410	54.98	0.0712	3.75	0.2
200	0.414	54.37	0.0700	3.25	0.4
220	0.419	53.76	0.0688	2.83	0.7
240	0.423	53.14	0.0676	2.48	1.1
260	0.428	52.53	0.0664	2.19	1.7
280	0.432	51.91	0.0652	1.94	2.6
300	0.437	51.28	0.0640	1.72	3.65
320	0.442	50.65	0.0628	1.54	5.08
340	0.446	50.02	0.0616	1.38	6.88
360	0.451	49.38	0.0604	1.24	9.11
380	0.455	48.73	0.0592	1.12	11.83
400	0.460	48.07	0.0580	1.01	15.08
420	0.464	47.40	0.0567	0.91	18.93
440	0.469	46.72	0.0555	0.83	23.42
460	0.473	46.04	0.0543	0.76	28.59
480	0.478	45.34	0.0531	0.69	34.48
500	0.482	44.62	0.0519	0.63	41.13
520	0.487	43.90	0.0507	0.58	48.58
540	0.491	43.15	0.0495	0.53	56.85
560	0.496	42.40	0.0483	0.49	65.97
580	0.500	41.63	0.0471	0.45	75.96
600	0.505	40.84	0.0459	0.42	86.84
620	0.510	40.03	0.0447	0.39	98.61
640	0.514	39.20	0.0435	0.36	111.29
660	0.519	38.36	0.0423	0.34	124.88
680	0.523	37.49	0.0411	0.31	139.39
700	0.528	36.60	0.0398	0.29	154.81
720	0.532	35.69	0.0386	0.27	171.14
740	0.537	34.76	0.0374	0.26	188.37
760	0.541	33.80	0.0362	0.24	206.50
780	0.546	32.82	0.0350	0.22	225.51
800	0.550	31.81	0.0338	0.21	245.39

Table 5 — Saturated Liquid Properties of SYLTHERM 800 Fluid (SI Units)

Temp. °C	Specific Heat kJ/kg K	Density kg/m ³	Thermal Conductivity W/m K	Viscosity mPa•s	Vapor Pressure kPa
-40	1.506	990.61	0.1463	51.05	0.0
-30	1.523	981.08	0.1444	35.45	0.0
-20	1.540	971.68	0.1425	25.86	0.0
-10	1.557	962.37	0.1407	19.61	0.0
0	1.574	953.16	0.1388	15.33	0.0
10	1.591	944.04	0.1369	12.27	0.0
20	1.608	934.99	0.1350	10.03	0.0
30	1.625	926.00	0.1331	8.32	0.0
40	1.643	917.07	0.1312	7.00	0.1
50	1.660	908.18	0.1294	5.96	0.20
60	1.677	899.32	0.1275	5.12	0.42
70	1.694	890.49	0.1256	4.43	0.81
80	1.711	881.68	0.1237	3.86	1.46
90	1.728	872.86	0.1218	3.39	2.47
100	1.745	864.05	0.1200	2.99	4.00
110	1.762	855.21	0.1181	2.65	6.22
120	1.779	846.35	0.1162	2.36	9.30
130	1.796	837.46	0.1143	2.11	13.5
140	1.813	828.51	0.1124	1.89	19.0
150	1.830	819.51	0.1106	1.70	26.1
160	1.847	810.45	0.1087	1.54	35.0
170	1.864	801.31	0.1068	1.39	46.0
180	1.882	792.08	0.1049	1.26	59.5
190	1.899	782.76	0.1030	1.15	75.6
200	1.916	773.33	0.1012	1.05	94.6
210	1.933	763.78	0.0993	0.96	116.8
220	1.950	754.11	0.0974	0.88	142.4
230	1.967	744.30	0.0955	0.81	171.7
240	1.984	734.35	0.0936	0.74	204.8
250	2.001	724.24	0.0918	0.69	242.1
260	2.018	713.96	0.0899	0.63	283.6
270	2.035	703.51	0.0880	0.59	329.6
280	2.052	692.87	0.0861	0.54	380.2
290	2.069	682.03	0.0842	0.50	435.4
300	2.086	670.99	0.0824	0.47	495.5
310	2.104	659.73	0.0805	0.44	560.5
320	2.121	648.24	0.0786	0.41	630.5
330	2.138	636.52	0.0767	0.38	705.6
340	2.155	624.55	0.0748	0.36	785.7
350	2.172	612.33	0.0729	0.33	870.9
360	2.189	599.83	0.0711	0.31	961.2
370	2.206	587.07	0.0692	0.29	1057
380	2.223	574.01	0.0673	0.28	1157
390	2.240	560.66	0.0654	0.26	1262
400	2.257	547.00	0.0635	0.25	1373

Figure 3 — Thermal Conductivity of SYLTHERM 800 Fluid (English Units)

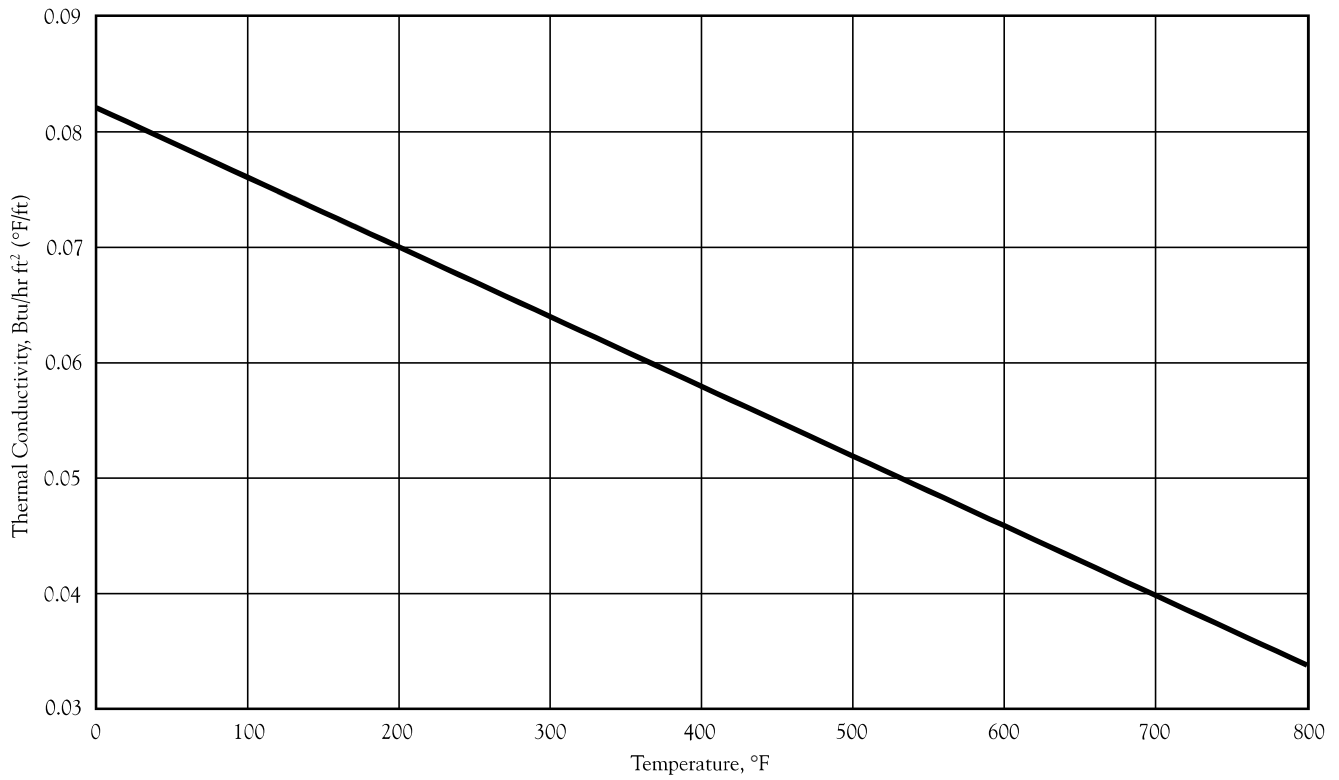

Figure 4 — Thermal Conductivity of SYLTHERM 800 Fluid (SI Units)

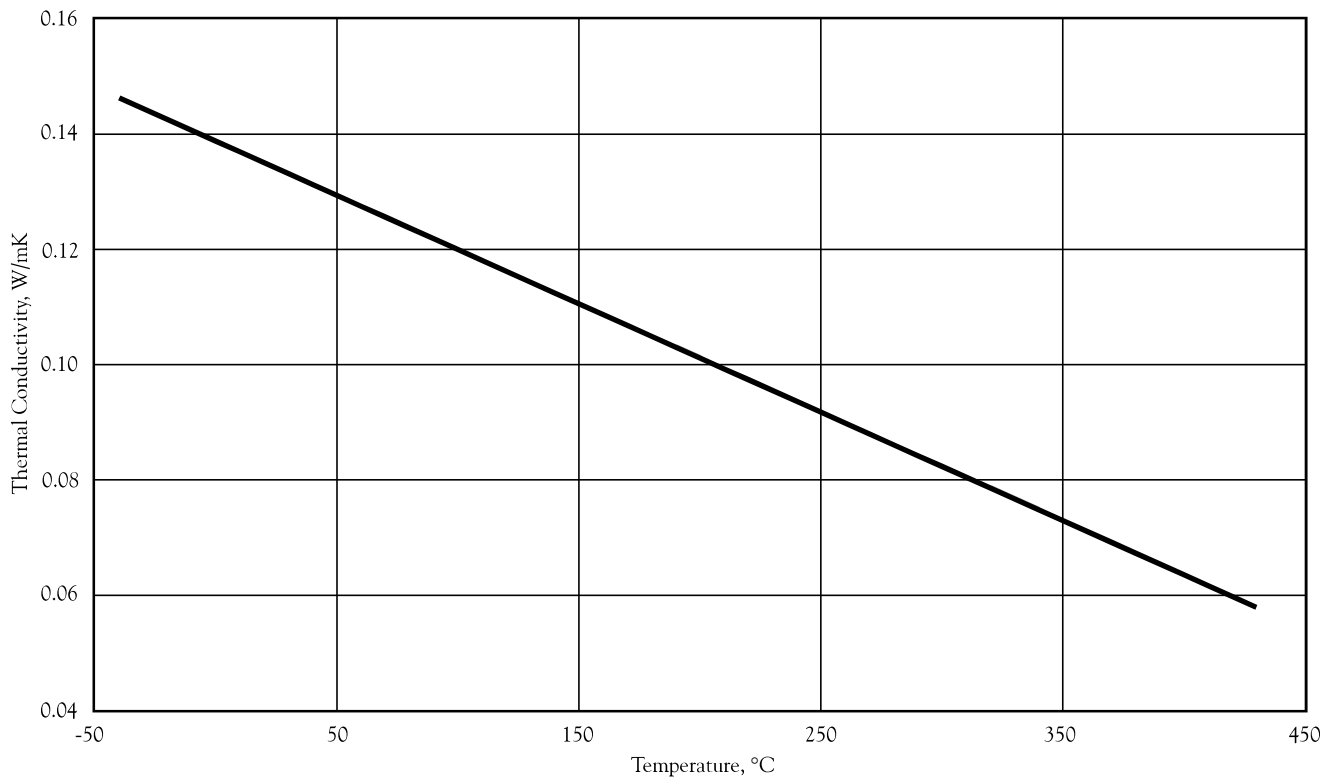

Figure 5 — Calculated Heat of Vaporization of SYLTHERM 800 Fluid (English Units)

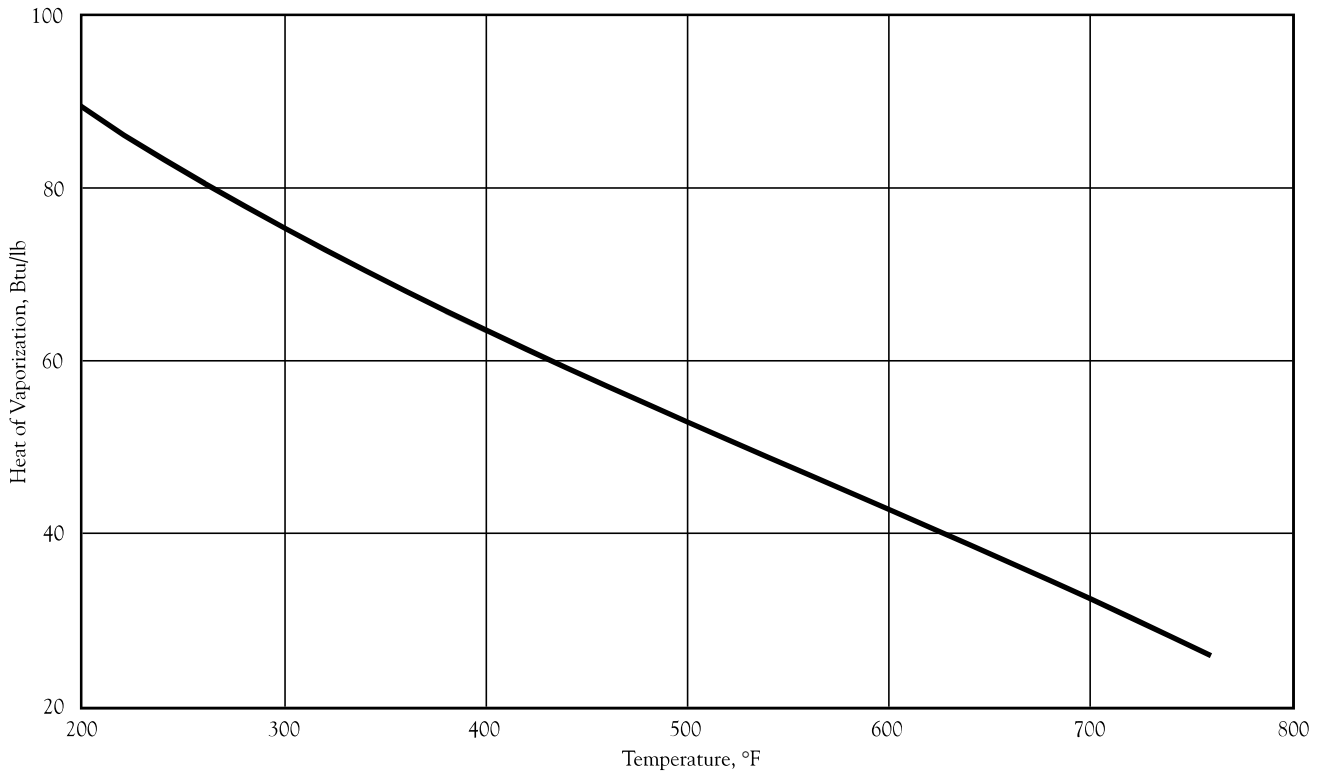

Figure 6 — Calculated Heat of Vaporization of SYLTHERM 800 Fluid (SI Units)

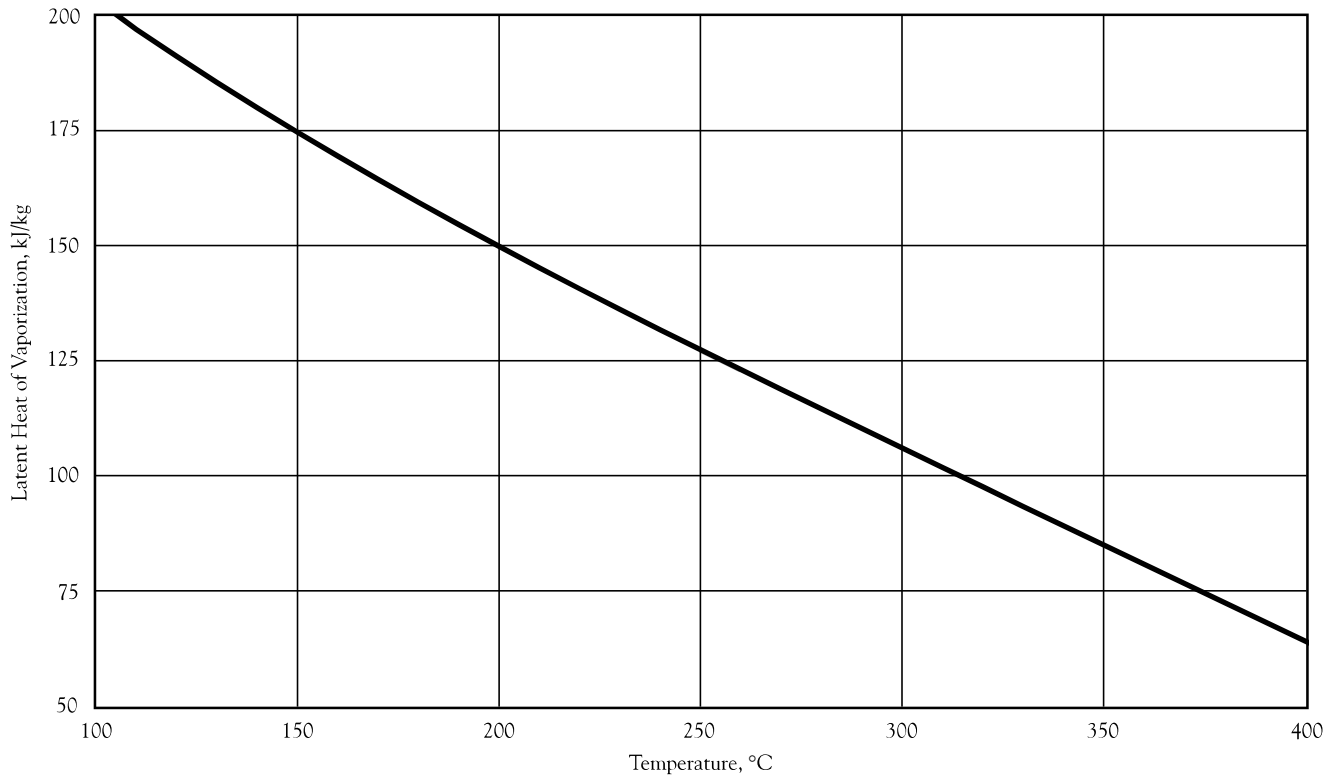

Figure 7 — Vapor Pressure of SYLTHERM 800 Fluid (English Units)

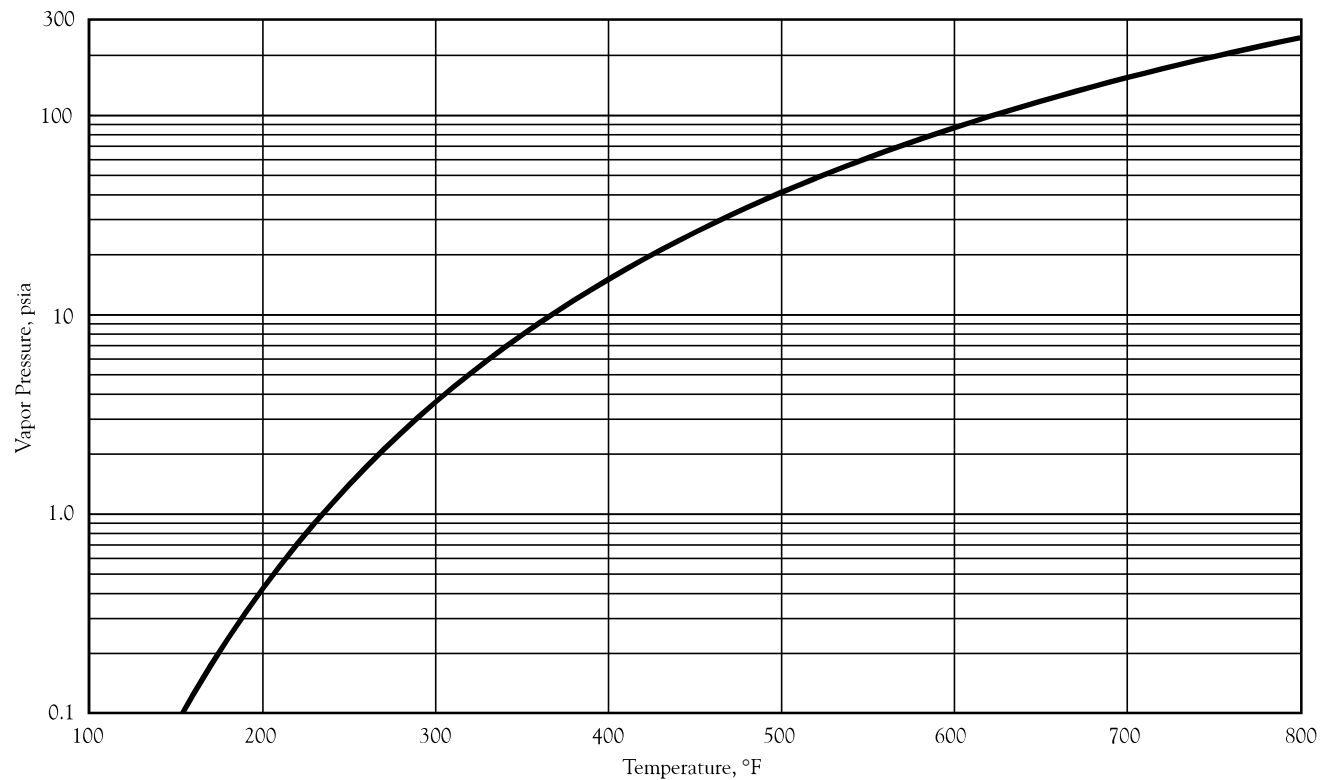

Figure 8 — Vapor Pressure of SYLTHERM 800 Fluid (SI Units)

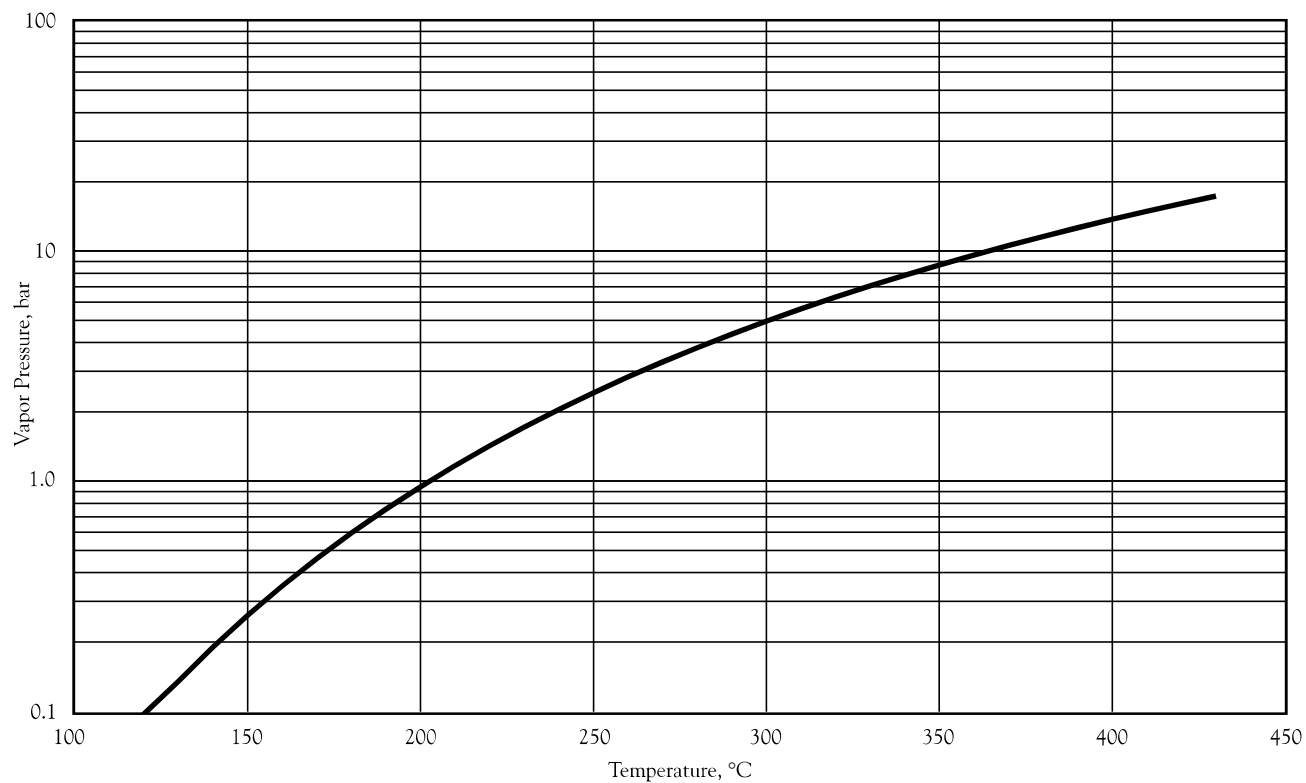

Figure 9 — Specific Heat of SYLTHERM 800 Fluid (English Units)

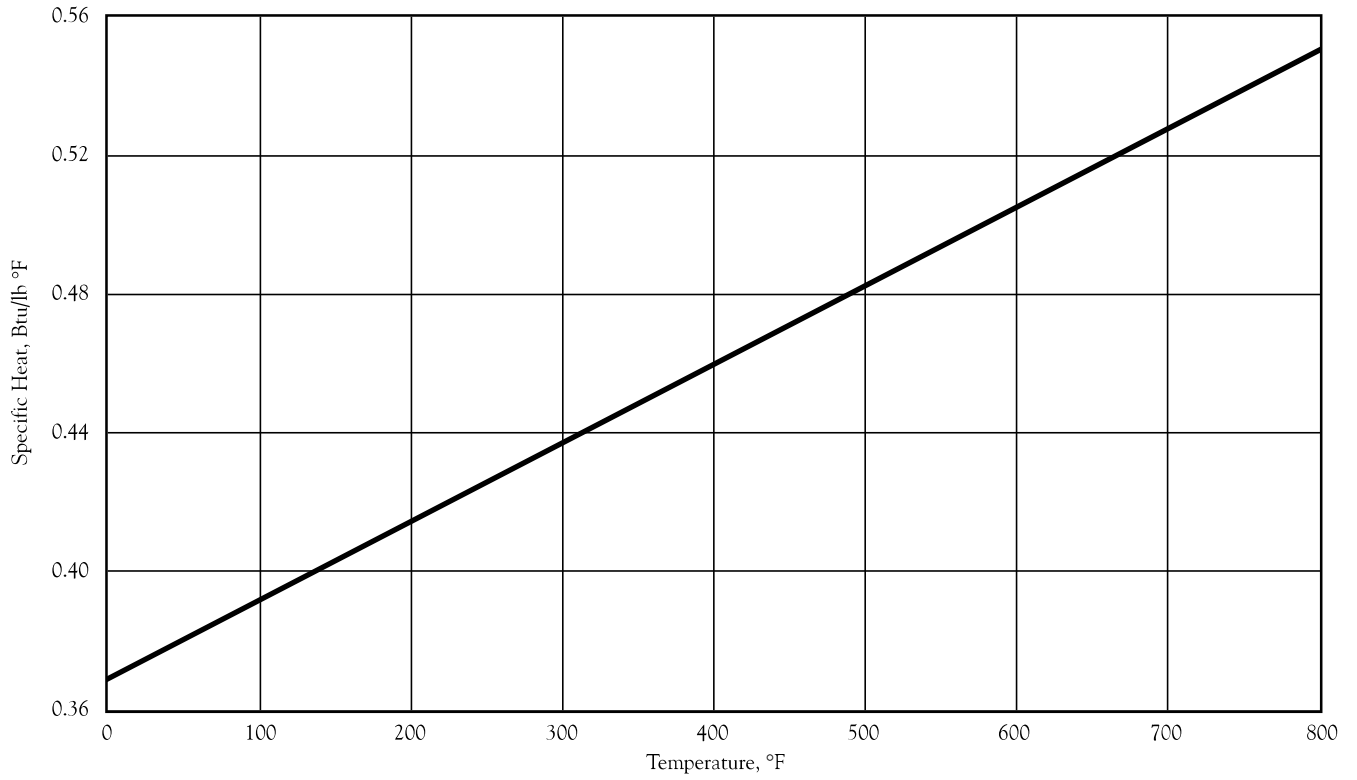

Figure 10 — Specific Heat of SYLTHERM 800 Fluid (SI Units)

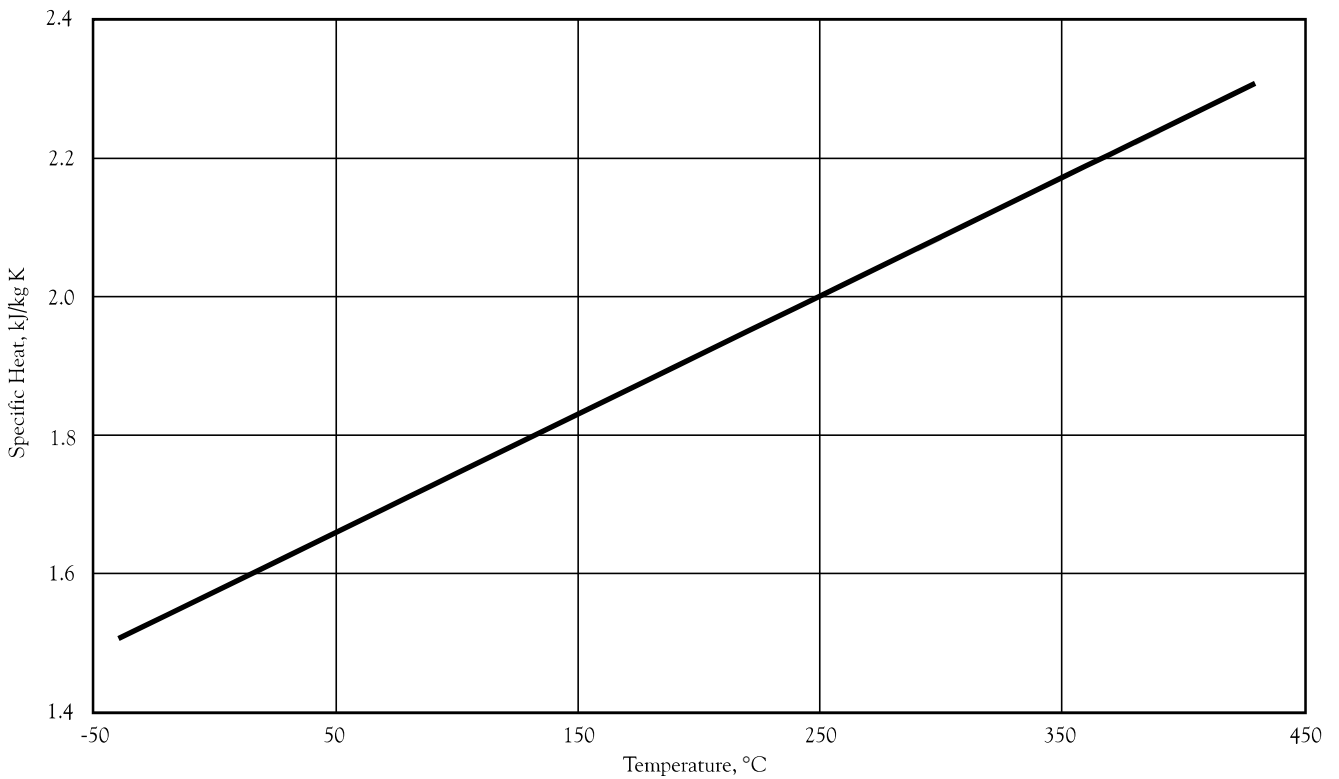

Figure 11 — Density of SYLTHERM 800 Fluid (English Units)

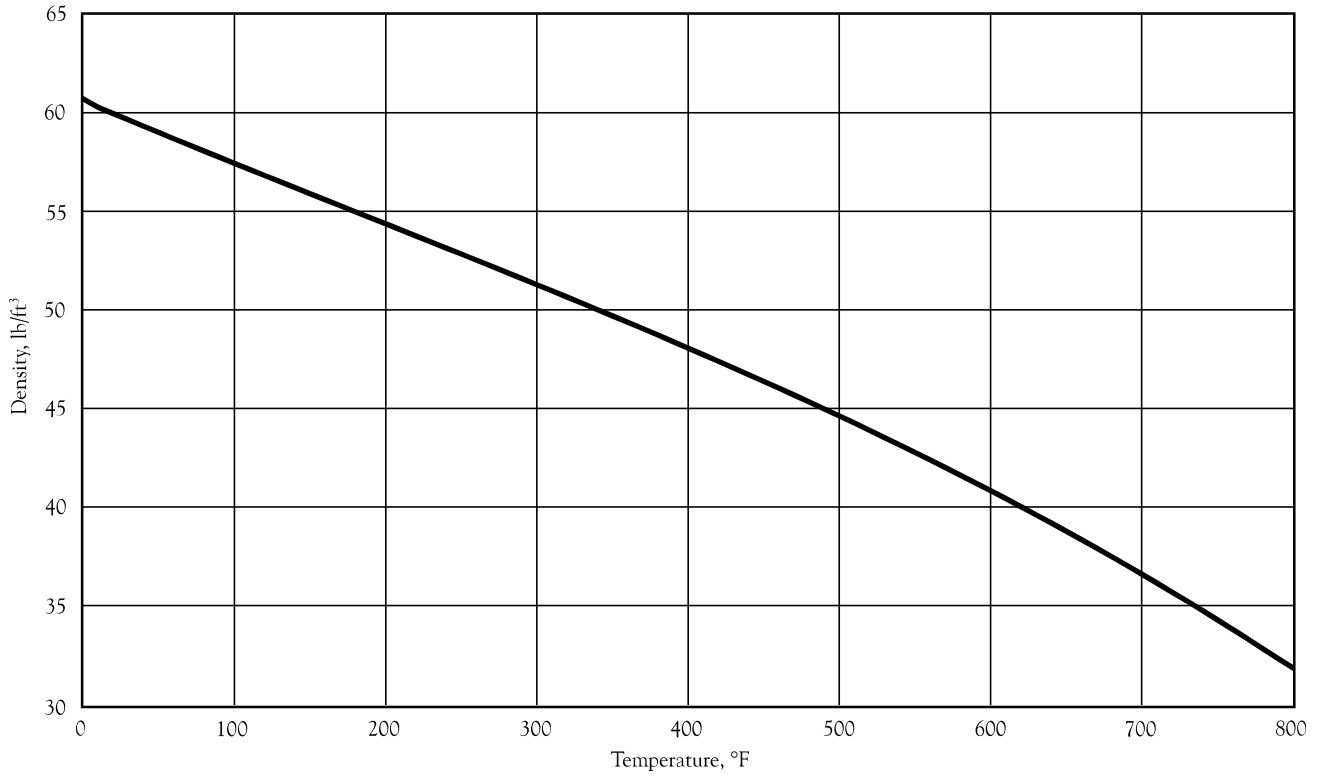

Figure 12 — Density of SYLTHERM 800 Fluid (SI Units)

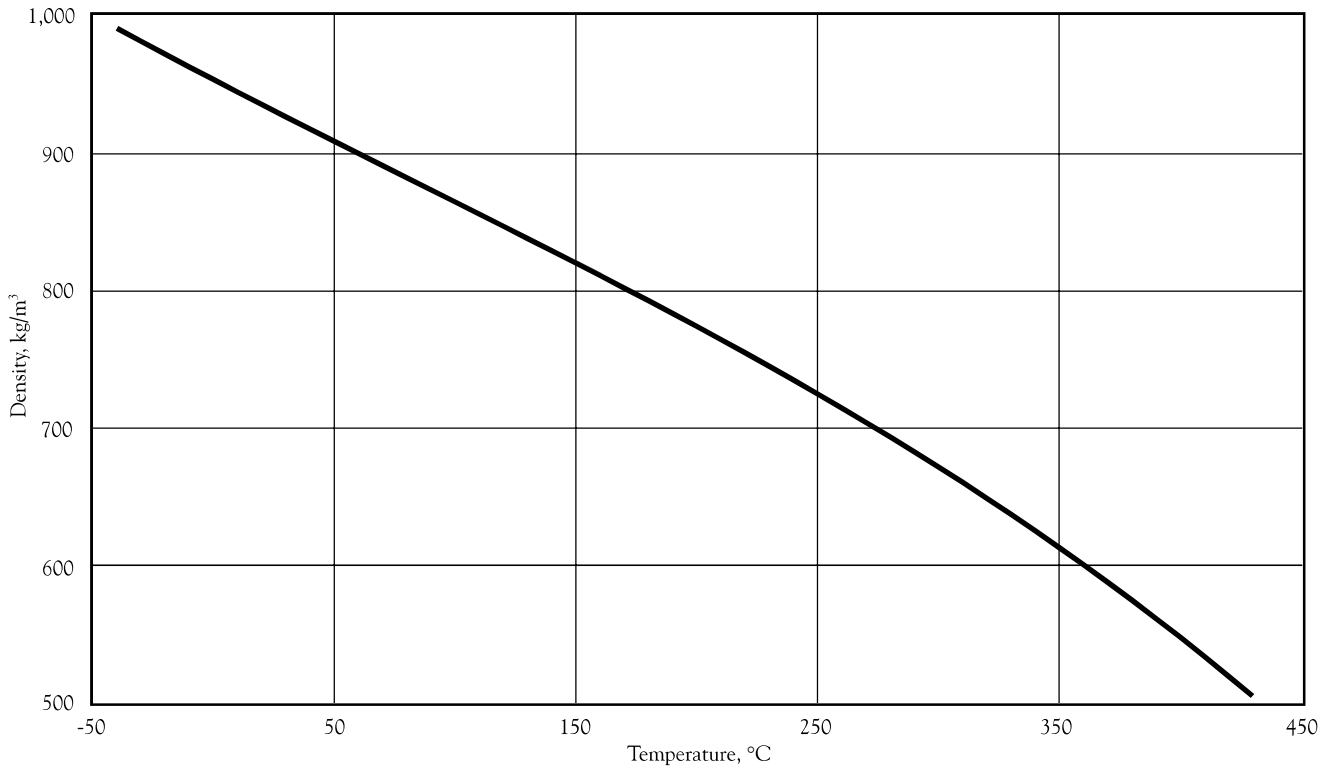

Figure 13 — Viscosity of SYLTHERM 800 Fluid (English Units)

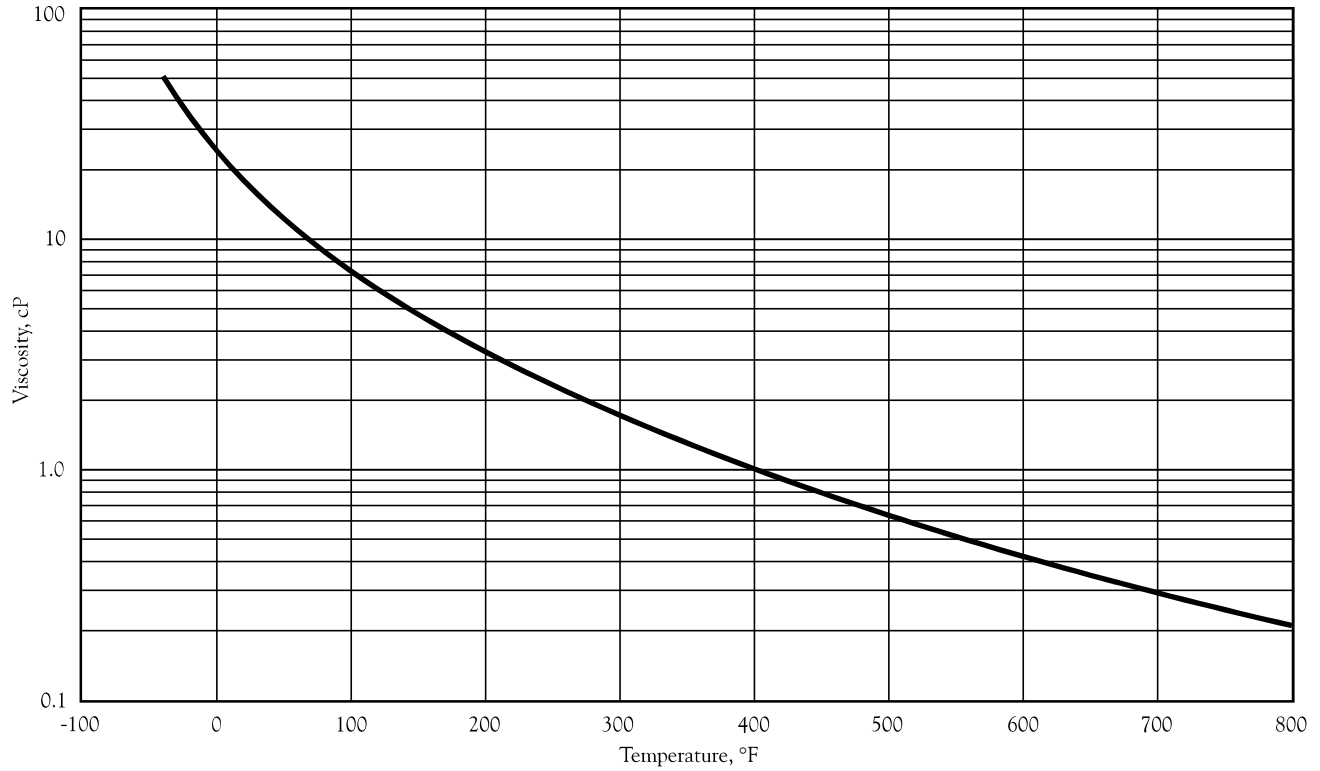

Figure 14 — Viscosity of SYLTHERM 800 Fluid (SI Units)

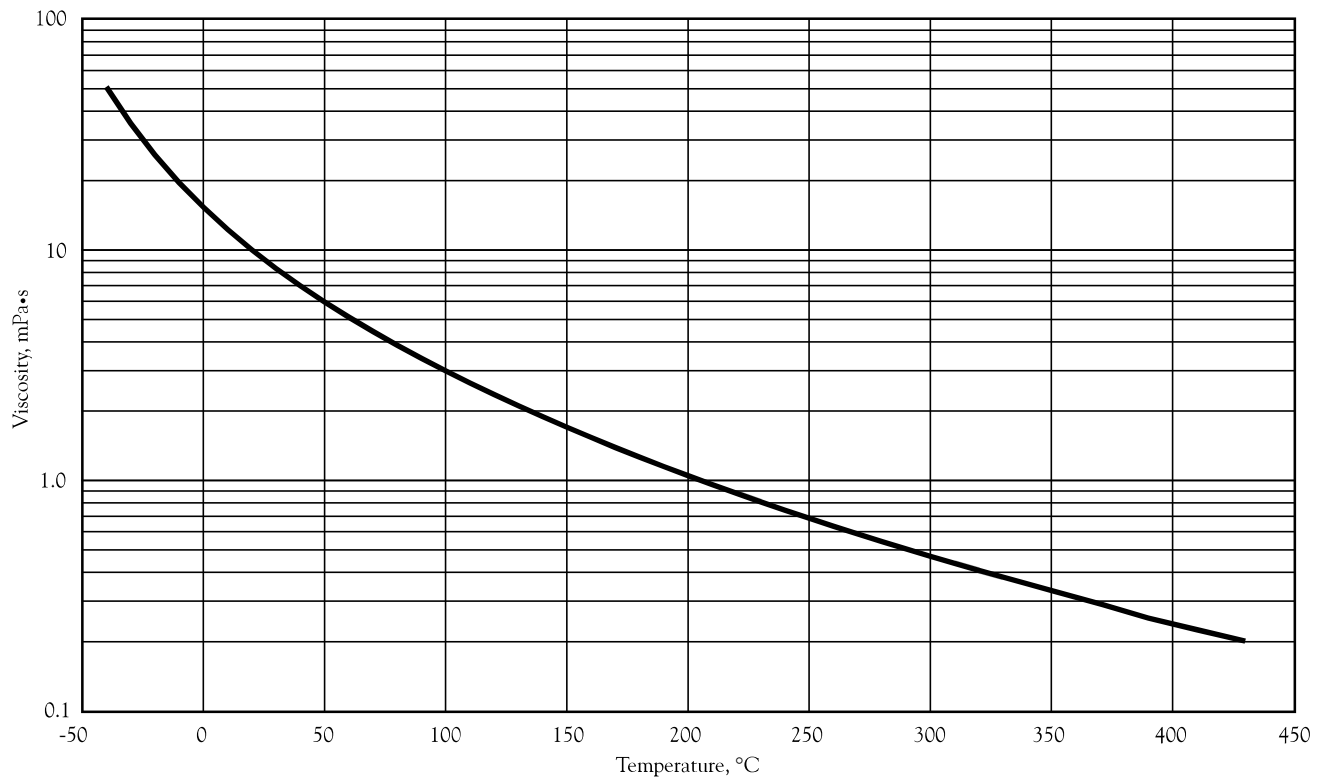
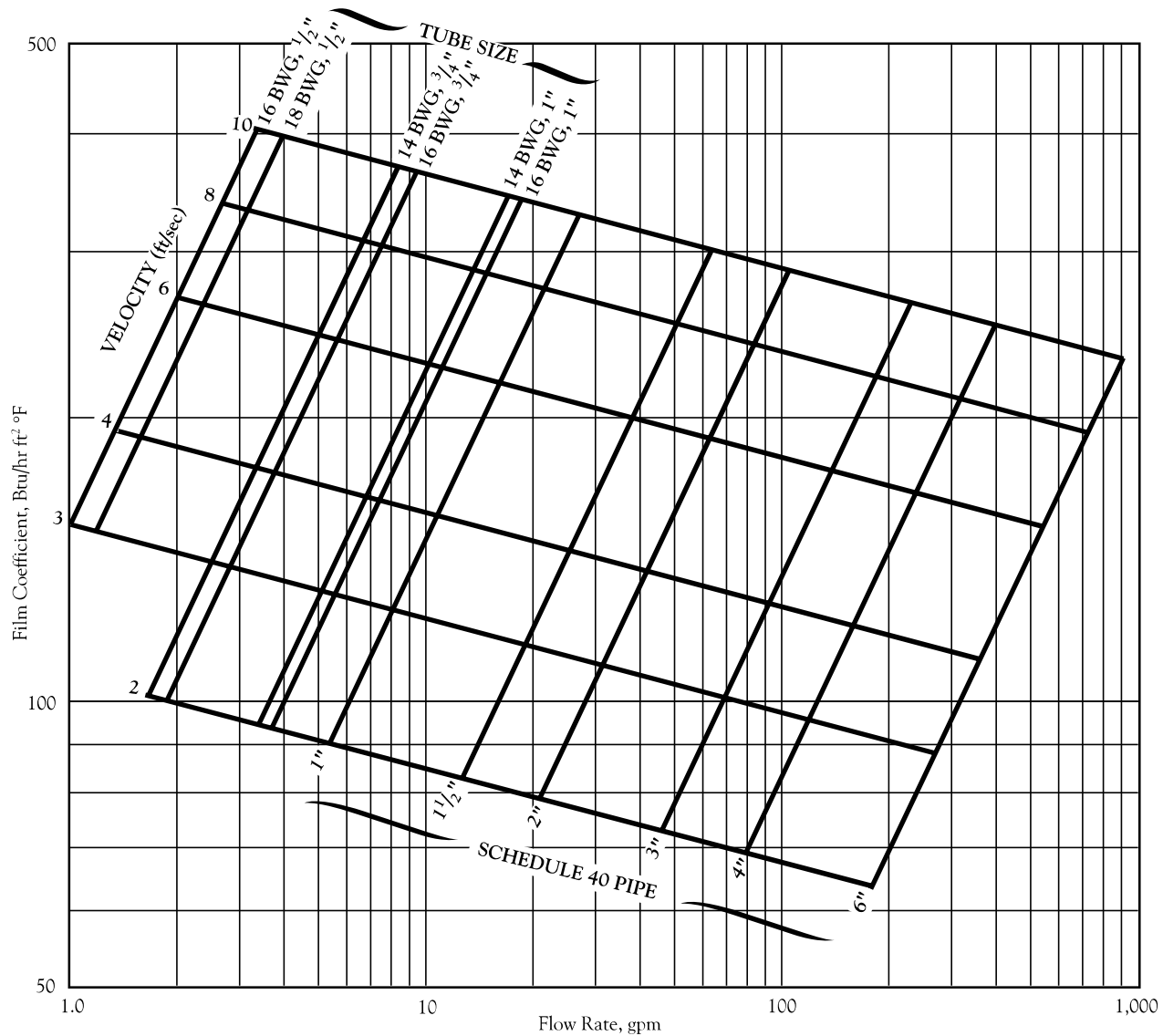
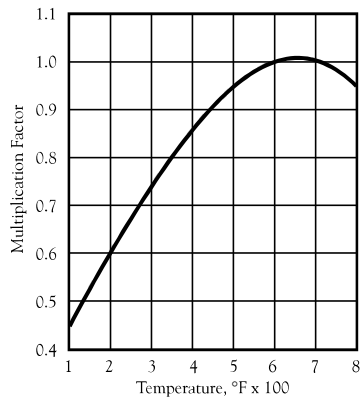

Figure 15 — Liquid Film Coefficient of SYL THERM 800 Fluid Inside Pipes and Tubes (Turbulent Flow Only) (English Units)



Temperature Correction Multiplier Factor



Sieder and Tate equation
Process Heat Transfer,
D.Q. Kern (1950) p.103

$$Nu = 0.027Re^{0.8}PR^{1/3} \left(\frac{\mu}{\mu_w} \right)^{0.14}$$

Chart based on $\left(\frac{\mu}{\mu_w} \right)^{0.14} = 1$

Note: The values in this graph are based on the viscosity of fluid as supplied.

Figure 16 — Liquid Film Coefficient of SYL THERM 800 Fluid Inside Pipes and Tubes (Turbulent Flow Only) (SI Units)

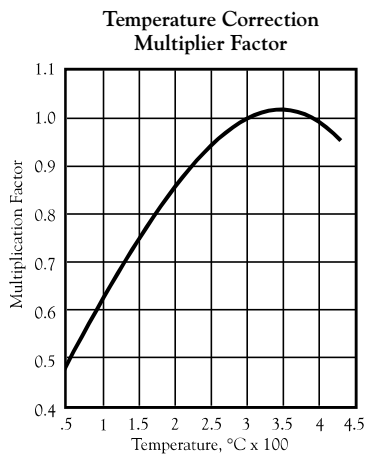
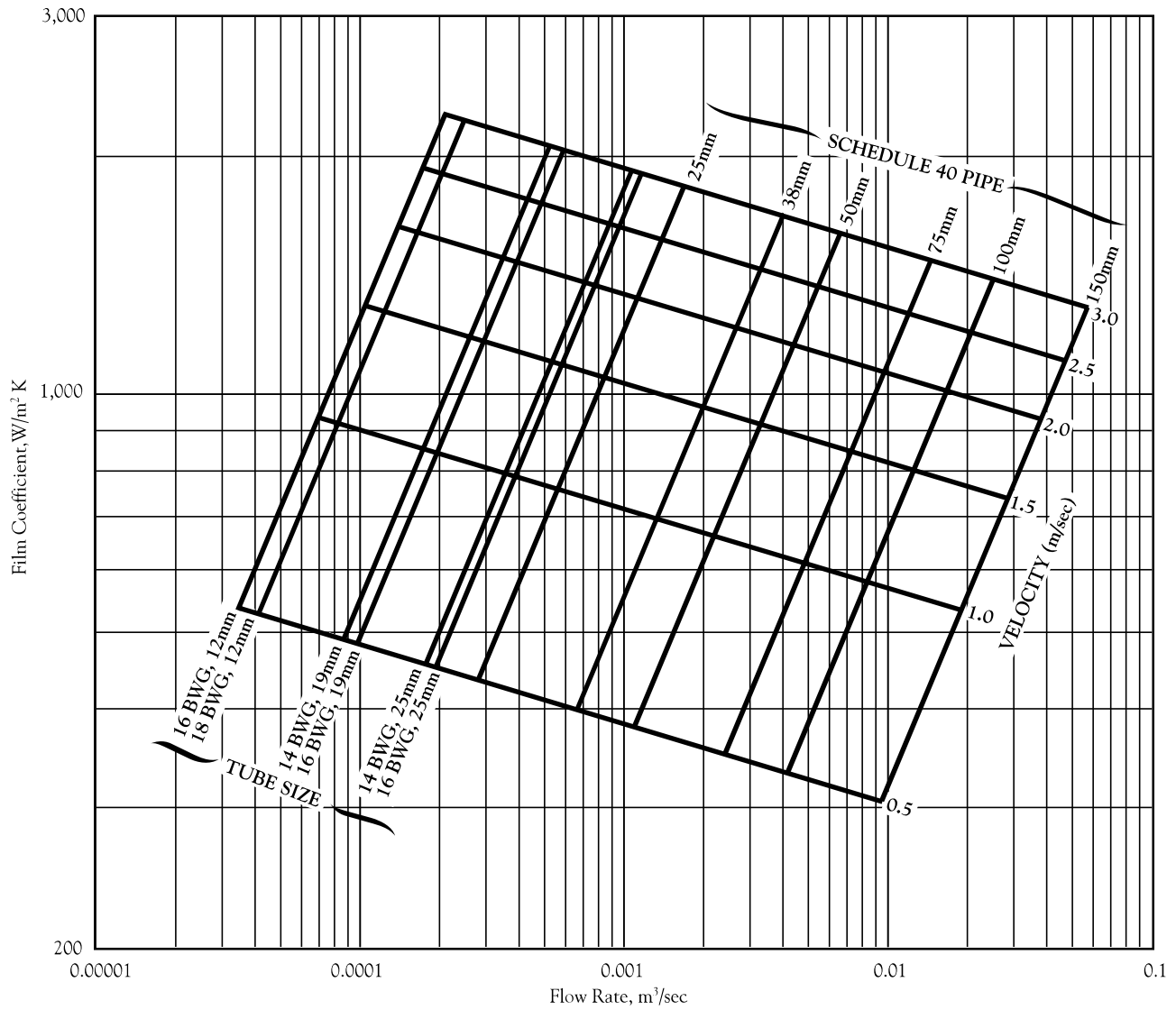

Sieder and Tate equation
Process Heat Transfer,
D.Q. Kern (1950) p.103

$$Nu = 0.027Re^{0.8}Pr^{1/3} \left(\frac{\mu}{\mu_w} \right)^{0.14}$$

Chart based on $\left(\frac{\mu}{\mu_w} \right)^{0.14} = 1$

Note: The values in this graph are based on the viscosity of fluid as supplied.

Figure 17 — Pressure Drop vs. Flow Rate of SYL THERM 800 Fluid in Schedule 40 Nominal Pipe and BWG Tube (English Units)

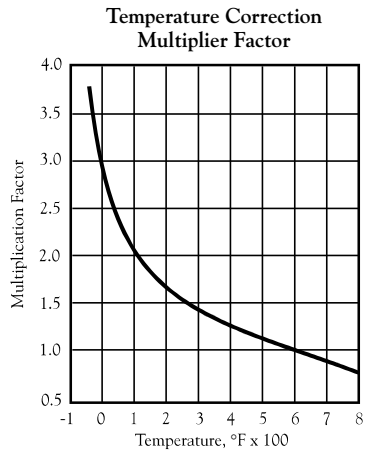
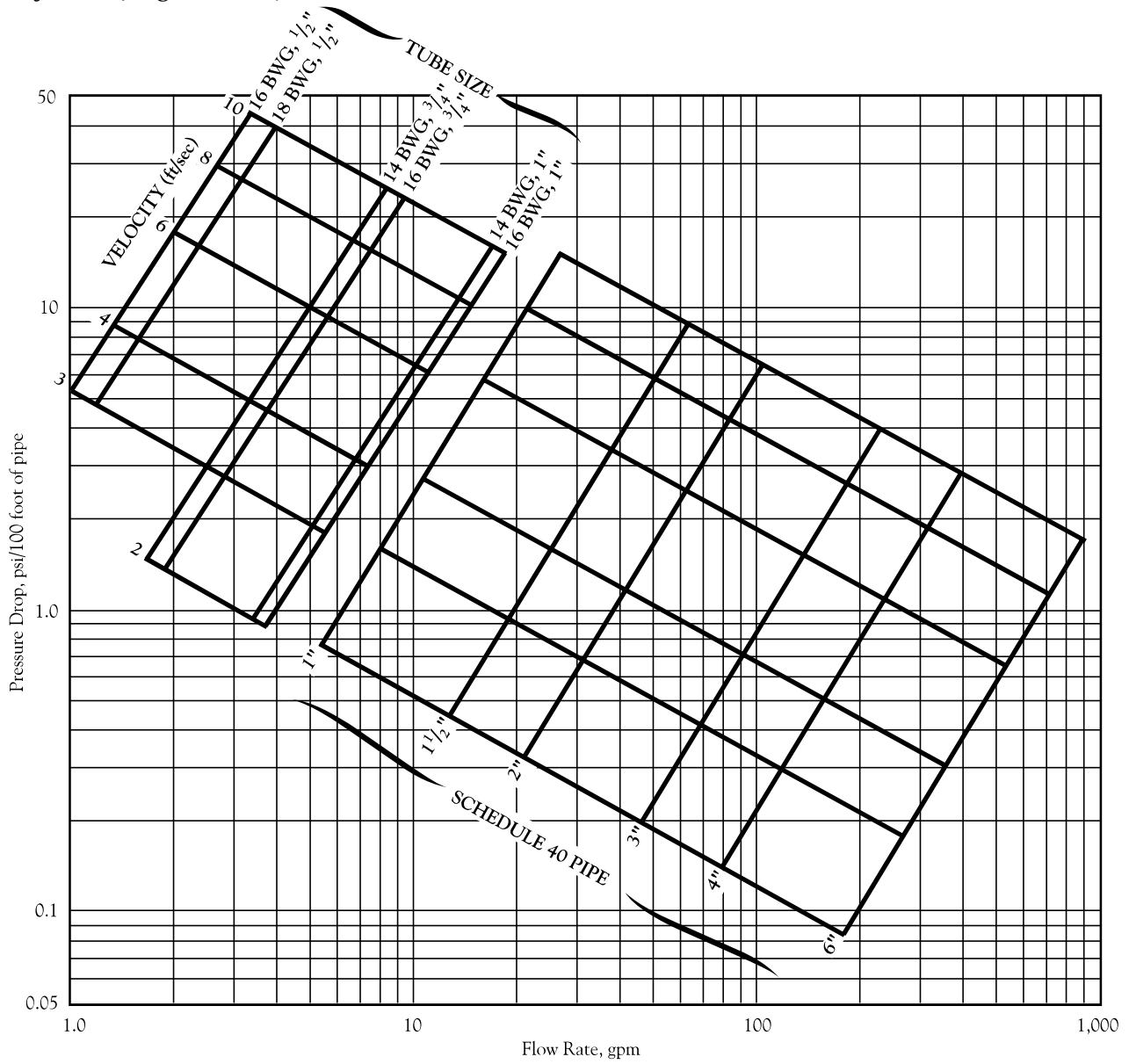

Figure 18 — Pressure Drop vs. Flow Rate of SYLThERm 800 Fluid in Schedule 40 Nominal Pipe and BWG Tube (SI Units)

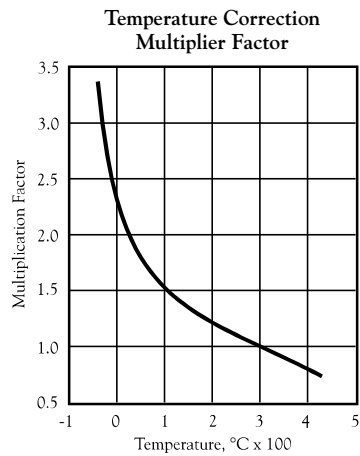
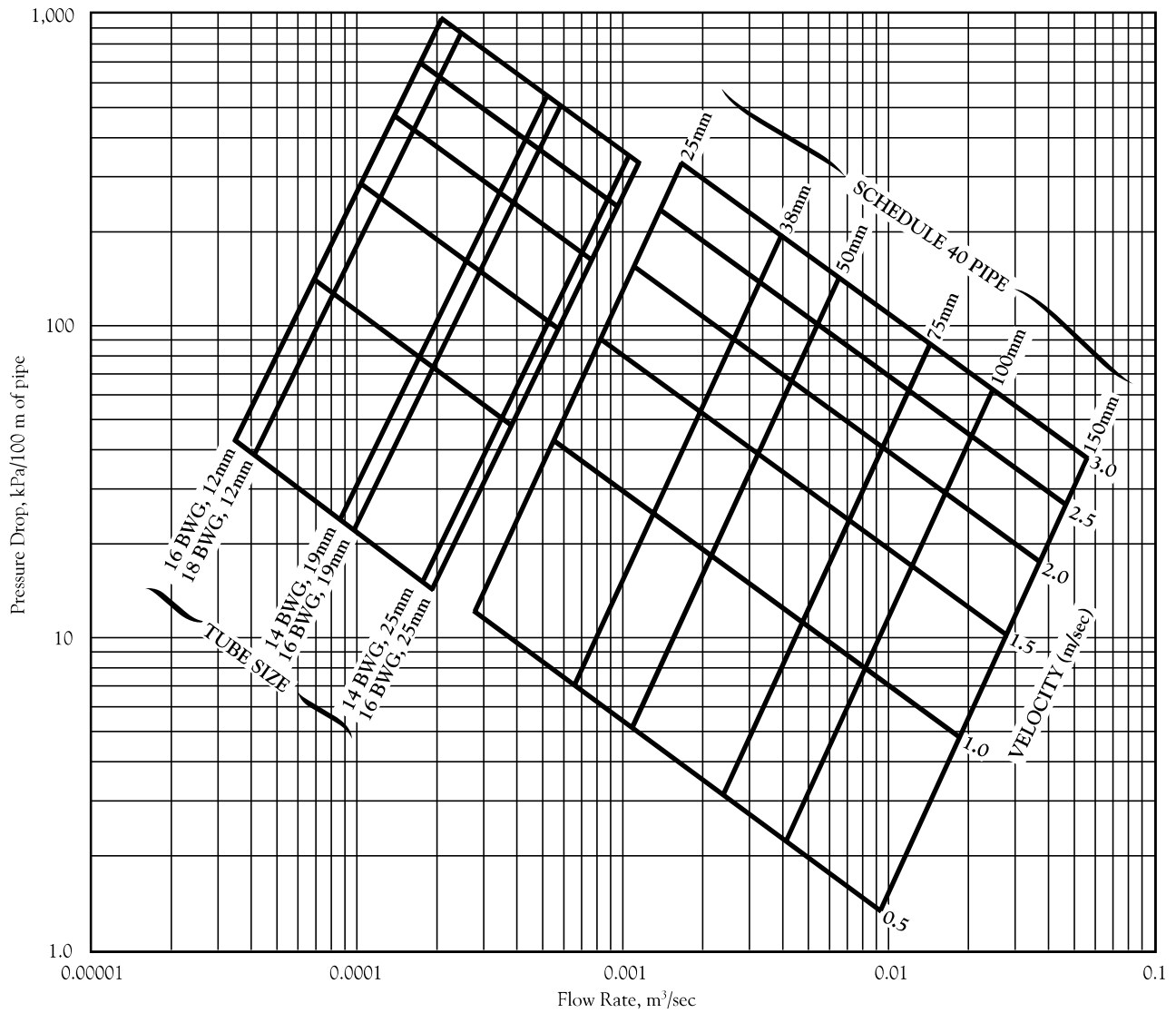

Figure 19 — Thermal Expansion of Liquid SYLTHERM 800 Fluid (English Units)

Basis: 1 gallon at 75°F

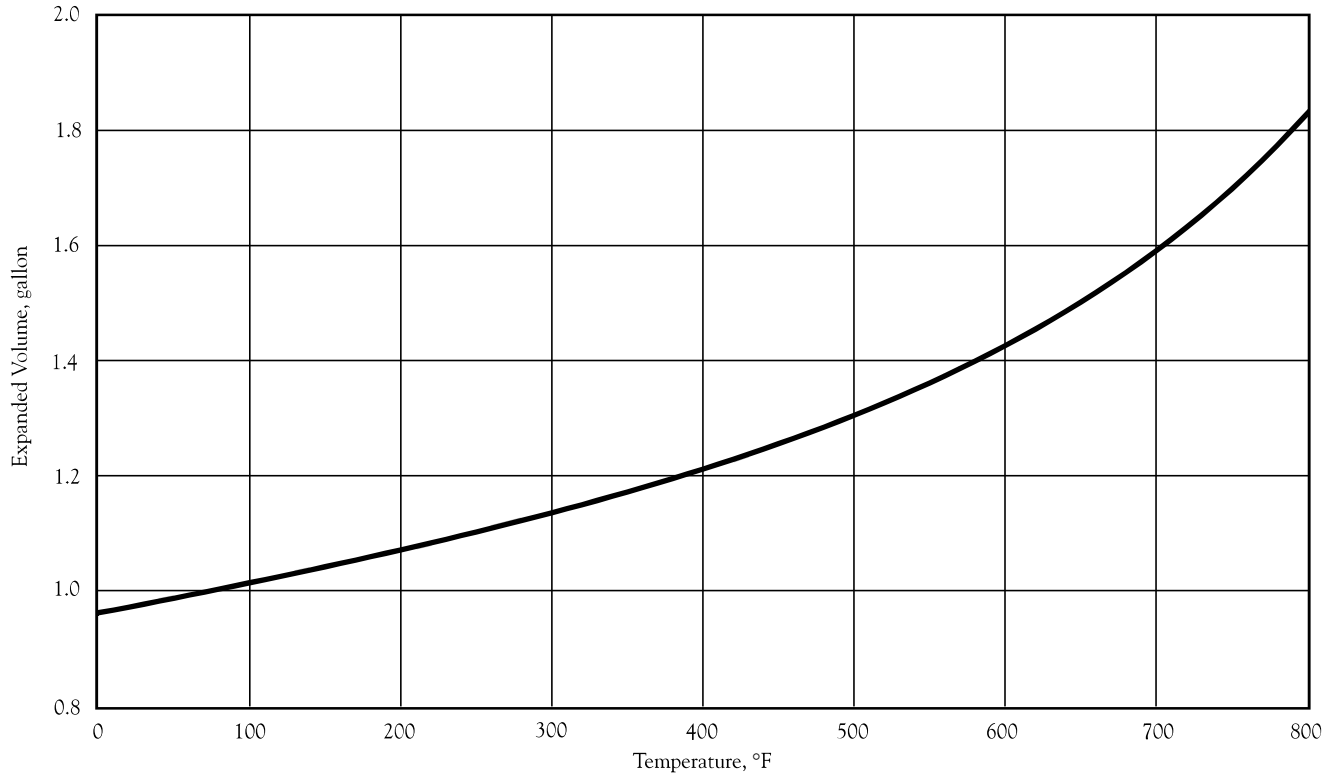

Figure 20 — Thermal Expansion of Liquid SYLTHERM 800 Fluid (SI Units)

Basis: 1 cubic meter at 25°C

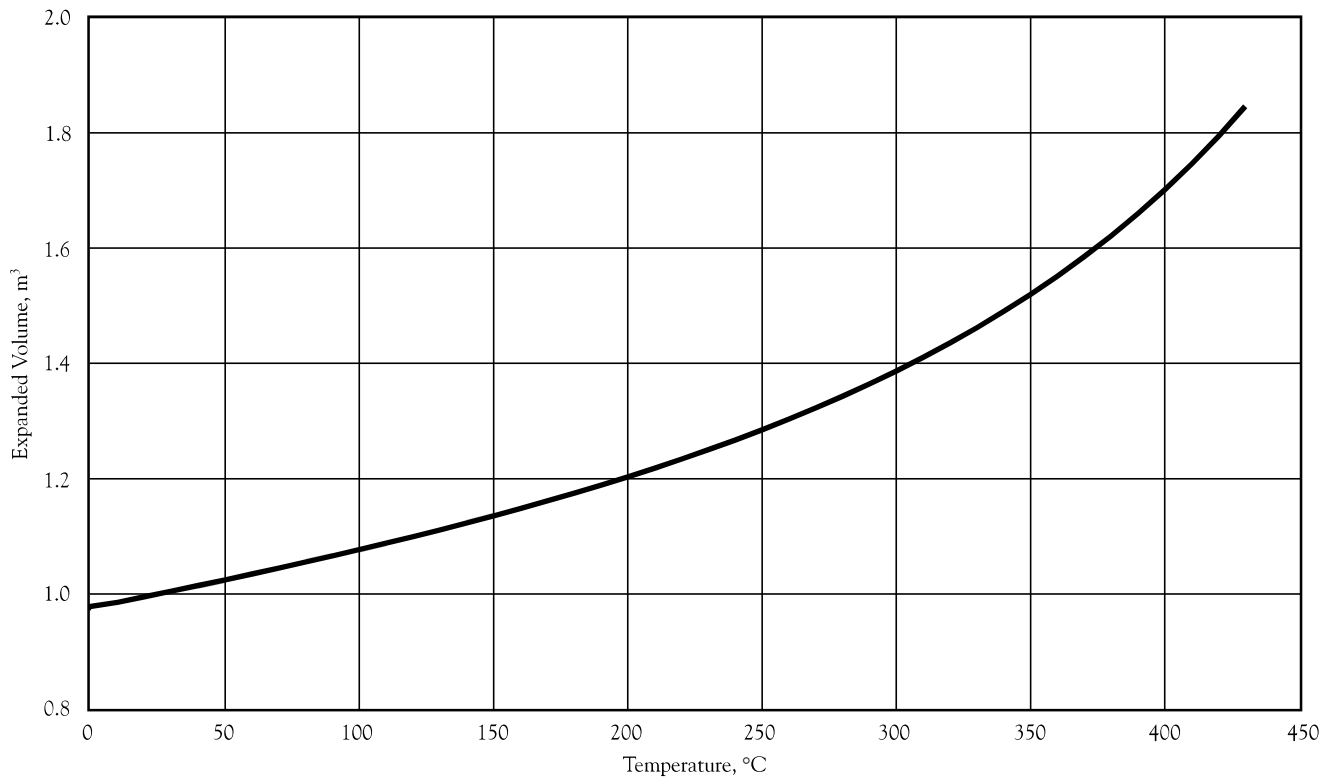
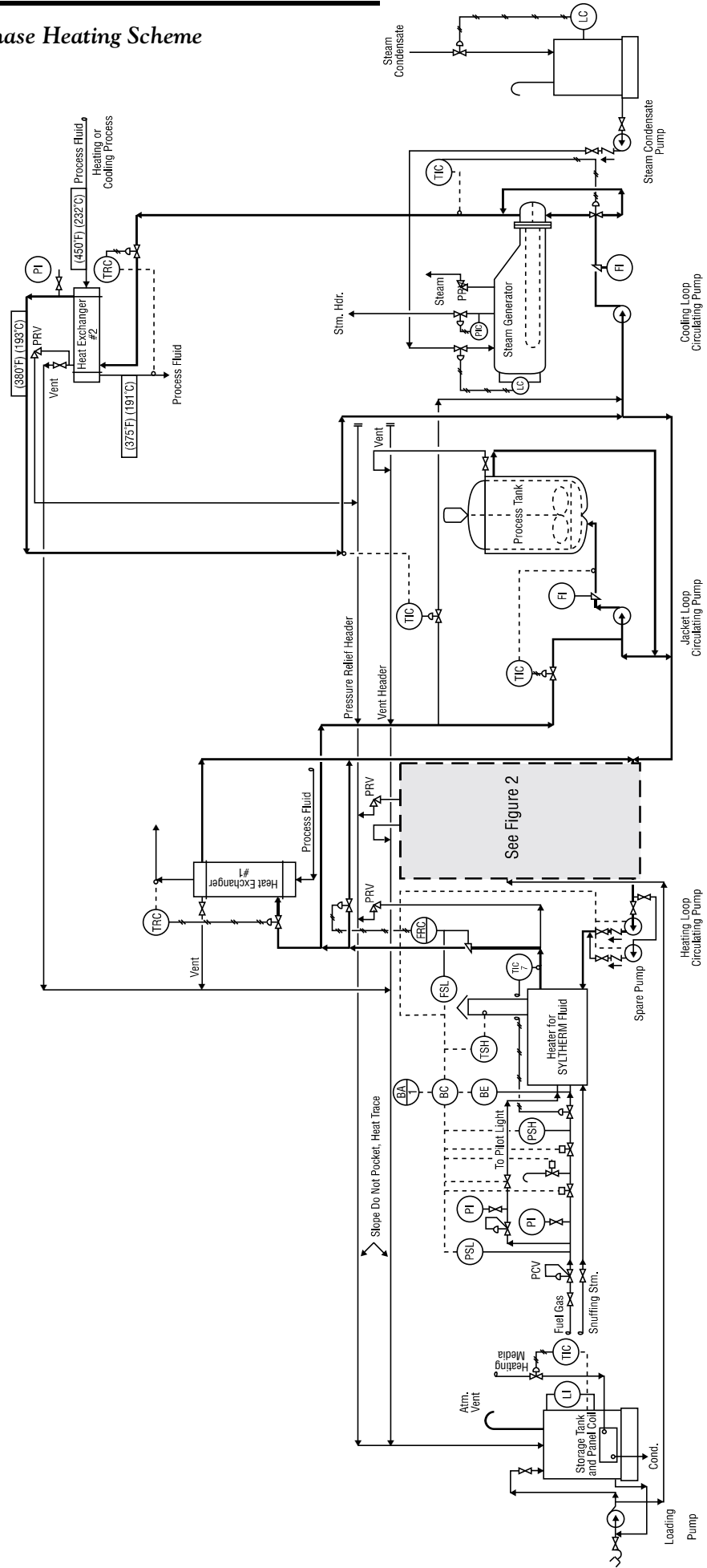

Figure 21 — Typical Liquid Phase Heating Scheme Using SYLTHERM Fluid

Instrument Legend

- BA — Burner Alarm
 - BC — Burner Control
 - BE — Burner Element (Fire-Eye)
 - FI — Flow Indicator (Orifice)
 - FRC — Flow Recording Controller
 - FSL — Flow Switch Low
 - LC — Level Controller
 - PVC — Pressure Control Valve
 - PI — Pressure Indicator
 - PIC — Pressure Indicating Controller
 - PRV — Pressure Relief Valve
 - PSH — Pressure Switch High
 - PSL — Pressure Switch Low
 - TIC — Temperature Indicating Controller
 - TRC — Temperature Recorder Controller
 - TSH — Temperature Switch High
-
- Principal Circuits with SYLTHERM Fluid
 - Electrical Lines
 - Instrument Air Lines



SYLTHERM 800 Heat Transfer Fluid

Product Technical Data

For further information, call...

In The United States And Canada: 1-800-447-4369 • FAX: 1-517-832-1465

In Europe: +31 20691 6268 • FAX: +31 20691 6418

In The Pacific: +886 2 715 3388 • FAX: +886 2 717 4115

In Other Global Areas: 1-517-832-1556 • FAX: 1-517-832-1465

<http://www.dow.com/heattrans>

NOTICE: No freedom from any patent owned by Seller or others is to be inferred. Because use conditions and applicable laws may differ from one location to another and may change with time, Customer is responsible for determining whether products and the information in this document are appropriate for Customer's use and for ensuring that Customer's workplace and disposal practices are in compliance with applicable laws and other governmental enactments. Seller assumes no obligation or liability for the information in this document. NO WARRANTIES ARE GIVEN; ALL IMPLIED WARRANTIES OF MERCHANTABILITY OR FITNESS FOR A PARTICULAR PURPOSE ARE EXPRESSLY EXCLUDED.

Published October 1997

NOTE: SYLTHERM heat transfer fluids are manufactured by Dow Corning Corporation and distributed by The Dow Chemical Company.

